



**DESIGN, CONSTRUCTION AND  
PERFORMANCE MONITORING OF  
COVER SYSTEMS FOR WASTE ROCK  
AND TAILINGS**

**VOLUME 3 – SITE CHARACTERIZATION AND  
NUMERICAL ANALYSES OF COVER PERFORMANCE**

**MEND 2.21.4c**

**This work was done on behalf of MEND and sponsored by:  
MEND and INCO Ltd.**

**July 2004**



Natural Resources Canada  
Ressources naturelles Canada  
CANMET

# DESIGN, CONSTRUCTION AND PERFORMANCE MONITORING OF COVER SYSTEMS FOR WASTE ROCK AND TAILINGS

MEND 2.21.4

## VOLUME 3

# SITE CHARACTERIZATION AND NUMERICAL ANALYSES OF COVER PERFORMANCE

Prepared for MEND

Funded by INCO Ltd.

Edited by:



*Integrated Geotechnical Engineering Services  
Specialists in Unsaturated Zone Hydrology*

OKC Report No. 702-01

**July 2004**

## SUMMARY

This manual includes a summary volume (Volume 1) and the following four supporting technical documents:

- Volume 2 – Theory and Background;
- Volume 3 – Site Characterization and Numerical Analyses of Cover Performance;
- Volume 4 – Field Performance Monitoring and Sustainable Performance of Cover Systems;  
and
- Volume 5 – Case Studies.

Volume 1 presented a general overview of the elements of conceptual cover design, site characterization, and numerical modelling. This volume presents additional information of the latter two topics.

The first three sections of this volume discuss site characterization and are divided into site characterization methods (Section 1), field characterization and sampling methods (Section 2), and laboratory methods (Section 3). The first section provides similar information to Volume 1 but both Section 2 and Section 3 include detailed descriptions of both field and laboratory testing methods. The laboratory testing methods include descriptions of the most common geotechnical and geochemical tests used for characterizing mine waste and cover materials for the design of cover systems.

The last section, Section 4, describes numerical modelling methods for cover design. A number of modelling examples are presented to expand on the information given in Volume 1.

## TABLE OF CONTENTS

<b>SUMMARY .....</b>	<b>I</b>
<b>TABLE OF CONTENTS.....</b>	<b>II</b>
<b>LIST OF TABLES.....</b>	<b>IV</b>
<b>LIST OF FIGURES .....</b>	<b>V</b>
<b>1 SITE CHARACTERIZATION.....</b>	<b>1</b>
1.1 COMPILING AND INTERPRETING EXISTING SITE DATA .....	1
1.2 COLLECTION OF EXISTING DATA.....	1
1.3 INITIAL MINE SITE SURVEY.....	2
<b>2 FIELD CHARACTERIZATION AND SAMPLING PROGRAMME .....</b>	<b>3</b>
2.1 EXCAVATION OF TEST PITS .....	3
2.2 COLLECTION OF SAMPLES FOR LABORATORY CHARACTERIZATION.....	3
2.3 <i>IN SITU</i> TESTS.....	5
<b>3 LABORATORY CHARACTERIZATION PROGRAMME.....</b>	<b>8</b>
3.1 RECOMMENDED GEOTECHNICAL TESTING PROGRAMME .....	8
3.1.1 <i>Particle Size Distribution Test</i> .....	8
3.1.2 <i>Atterberg Limits</i> .....	9
3.1.3 <i>Specific Gravity Test</i> .....	9
3.1.4 <i>Compaction (Proctor) Test</i> .....	10
3.1.5 <i>Saturated Hydraulic Conductivity Test</i> .....	10
3.1.6 <i>Consolidation-Saturated Hydraulic Conductivity Test</i> .....	12
3.1.7 <i>Soil Water Characteristic Curve Test</i> .....	13
3.2 RECOMMENDED GEOCHEMICAL TESTING PROGRAMME .....	16
3.2.1 <i>Paste pH and Conductivity</i> .....	17
3.2.2 <i>The Modified Acid Base Accounting (ABA)</i> .....	18
3.2.3 <i>Static Net Acid Generation (NAG) Test</i> .....	19
3.2.4 <i>Kinetic Net Acid Generation (NAG) Test</i> .....	19
3.2.5 <i>Leach Extraction Test</i> .....	20
3.2.6 <i>Forward Acid Titration (Acid Base Characteristic Curve)</i> .....	20
3.2.7 <i>Measurement of the Oxidation Rate Coefficient</i> .....	20

<b>4</b>	<b>NUMERICAL MODELLING FOR COVER SYSTEM DESIGN .....</b>	<b>21</b>
4.1	APPROACH TO NUMERICAL MODELLING .....	21
4.1.1	<i>Input</i> .....	21
4.1.2	<i>Output</i> .....	22
4.2	NUMERICAL MODELLING METHODOLOGIES .....	24
4.2.1	<i>Purpose and Scope of Cover Design Modelling</i> .....	25
4.2.2	<i>Application of the Modelling Methodology</i> .....	25
4.3	DEMONSTRATION OF THE SOILCOVER MODEL.....	28
4.3.1	<i>Modelling Example 1</i> .....	29
4.3.2	<i>Modelling Example 2</i> .....	36
4.4	TWO-DIMENSIONAL MODELLING .....	45
4.4.1	<i>Steady-State Analysis</i> .....	48
	<b>REFERENCES .....</b>	<b>52</b>

## LIST OF TABLES

Table 3.1	Summary of saturated salt solution humidity and equivalent total suction (from Young (1967)).....	16
Table 3.2	Material classification based on ABA results. ....	19
Table 4.1	Modelling parallels to the scientific method.....	25
Table 4.2	Summary of sensitivity soil-atmosphere cover design model variables.....	34
Table 4.3	Summary of the SoilCover simulations. ....	41
Table 4.4	Summary of the results of the SoilCover simulations.....	43
Table 4.5	Summary of the SEEP/W models. ....	46
Table 4.6	Summary of total flow diverted from the underlying waste rock with high quality cover system. ....	49
Table 4.7	Summary of the total flow diverted from the waste rock with compacted material. ....	50

## LIST OF FIGURES

Figure 2.1	A 2.0 m test pit excavated in waste rock material.....	4
Figure 2.2	Large-scale field screen (grizzly) used to remove material greater than 100 mm. ....	4
Figure 2.3	Sampling borrow pit material.....	5
Figure 2.4	Field hydraulic conductivity testing.....	7
Figure 3.1	Schematic of a constant head permeameter apparatus. ....	11
Figure 3.2	Schematic of a modified oedometer apparatus (after O’Kane, 1996).....	13
Figure 4.1	Conceptual illustration of net percolation. ....	23
Figure 4.2	Predicted net percolation from a cover system utilizing moderate quality compacted layer (saturated hydraulic conductivity $\approx 1 \times 10^{-6}$ cm/s).....	31
Figure 4.3	Predicted net percolation from a cover system utilizing high quality compacted layer (saturated hydraulic conductivity $\approx 5 \times 10^{-8}$ cm/s). ....	31
Figure 4.4	Predicted return periods of net percolation for the moderate and high quality cover systems.....	33
Figure 4.5	Summary of sensitivity analysis for the high quality cover system. ....	34
Figure 4.6	A multi-layer cover system over waste material.....	39
Figure 4.7	Example of a “barrier” layer cover system on a sloping waste rock surface.....	47
Figure 4.8	Example of a “transmission” cover system on a sloping waste rock surface.....	48
Figure 4.9	Graphical output for steady-state model Capillary2b. ....	50

## **1 SITE CHARACTERIZATION**

This manual focuses on the elements of site characterization that are required for the design of soil cover systems. However, it is fundamental to note that site characterization should also include an assessment of the contaminant source and potential impacts of any contaminant release. These site characterization components are not within the scope of this manual.

Site characterization with respect to the design of soil cover systems for mine waste requires an understanding of the local natural landform as well as the mining features such as open pits, waste rock piles, and tailings storage facilities. The availability of potential cover materials and the objectives of the cover system, such as whether it limits the infiltration of water and / or oxygen, have a large influence on the cover system design. The characterization of the available materials at or near the mine site helps to evaluate which, if any, of the existing soils may be suitable for use as cover materials. The objectives of this materials investigation are to classify the types of all potential borrow materials available on site, including benign or “clean” waste material sources and to define the horizontal and vertical limits of these deposits.

In general, the materials characterization activities can be grouped the following categories: 1) compiling and interpreting existing site data, 2) field characterization and sampling, and 3) material testing.

### **1.1 Compiling and Interpreting Existing Site Data**

Preparations for the materials investigation programme should begin one to two months prior to commencement. Preparation work includes the collection of all existing site data and an initial survey of the mine site. Each will assist in identifying the appropriate areas in which field sampling test pits should be excavated.

### **1.2 Collection of Existing Data**

In many parts of the world, new mining operations or recently developed mining operations have completed environmental impact assessments (EIA). These documents summarize investigations of pre-existing sub-surface and surface conditions and estimate the characteristics of the mine waste rock piles and tailings storage facilities. The EIA includes data such as the assessment of the regional geology, hydrogeology, surface topography and hydrology, climate, and the biological ecosystem.

Environmental impact assessments will not be available at all mine sites; however, most operations have a large amount of historical information. Collection of data such as borehole logs, groundwater



piezometric data, and previous reports will assist in identifying the location and type of potential cover materials on the mine site.

### **1.3 Initial Mine Site Survey**

The initial mine site survey is a quick (less than one day) inspection of the potential cover materials available on the mine site. The survey should be conducted with the accompaniment of mine site personnel with a good knowledge of the mine site materials (e.g. mine site geologists, environmental officers). The area on which the cover system will be placed should first be examined. An estimate of the size of the area is needed to judge the required volume of cover materials. The potential cover materials, including any suitable waste rock or tailings material, should be roughly grouped into the following categories:

- Topsoil – this material is often rich in organic matter and nutrients and is desirable for the top surface of a cover system to assist in reclamation efforts;
- Well-graded material – this material is desirable for use in moisture store-and-release cover systems and can also act as an overlying growth medium layer in hydraulic barrier and capillary break cover systems;
- Clay or clayey / silty material – this material can be used to create a low hydraulic conductivity “barrier” layer; and
- Competent, coarse material – this material can armour the cover system against erosion, especially on sloping surfaces.

The location of each type of material and its distance from the area to be covered should be noted.

In addition to evaluating potential cover materials, the development of a defensible cover system design requires detailed information with respect to the underlying materials. Hence, site characterization will also require sampling of the mine waste and overburden (tailings, waste rock, spent heap leach material), some of which may be potentially acid generating, so that hydraulic material properties for these materials can also be determined.

## 2 FIELD CHARACTERIZATION AND SAMPLING PROGRAMME

A field characterization and sampling programme consists of the excavation of test pits, sample collection for geotechnical and geochemical testing, and the completion of the *in situ* field tests.

### 2.1 Excavation of Test Pits

Excavation of test pits is a relatively straightforward method of material sampling and characterization. The wall of the excavation allows a visual inspection of the material, so that textural and moisture content variations with depth can be described. As the pits are excavated, material samples can be taken and *in situ* testing can be performed at various depths.

Test pits in waste rock and borrow materials are typically excavated using a rubber-tired backhoe or excavator. The backhoe has the ability to dig through most materials and is relatively mobile. If deeper test pits are deemed necessary, or surface conditions are not conducive to using the backhoe, then the excavator may be required. Sampling of tailings material can also be completed using a backhoe provided the surface of the tailings is stable. Alternatively, it is common for samples to be collected by augering, which can be done manually, using a small drill rig mounted on a light vehicle, or using a small portable drill rig.

Before excavation, the location of the test pit is recorded (ideally “marked” using a portable GPS unit) and the desired depth and sampling programme for the test pit is identified. Representative samples are collected from each distinct material type encountered in the test pit. If the material within the test pit is homogeneous, samples are collected at recorded depths. The type and condition of any existing vegetation in the test pit area should also be recorded to assist with evaluating the materials’ suitability as a growth medium. Figure 2.1 shows an excavated trench in oxide waste rock material.

### 2.2 Collection of Samples for Laboratory Characterization

Material samples are generally collected in the field for both geotechnical and geochemical testing purposes. The samples taken are generally small or large grab samples, depending on the characterization test to be performed on the sample. For example, samples for particle size distribution and detailed geotechnical testing are typically placed in a number of 20 litre pails, while smaller re-sealable bags are used to collect samples for moisture content and geochemical testing. In general, particles greater than 100 mm are not included in the samples collected for laboratory characterization. Figure 2.2 shows a large-scale field screen, or grizzly, which provides the necessary separation of material (i.e. less than 100 mm) prior to collection in the 20 litre buckets.



**Figure 2.1** A 2.0 m test pit excavated in waste rock material.



**Figure 2.2** Large-scale field screen (grizzly) used to remove material greater than 100 mm.



It is beneficial to collect duplicate samples during the test pit excavation, even if rigorous testing is not planned. The primary cost associated with a sampling programme is the earth moving equipment and personnel required to conduct the sampling. The incremental cost to collect duplicate samples for future potential physical and geochemical testing is small and offers significant saving should re-sampling be required. Figure 2.3 shows sampling of borrow pit material.



**Figure 2.3** Sampling borrow pit material.

### **2.3 *In Situ* Tests**

The *in situ* tests include paste pH / paste conductivity, sampling for gravimetric moisture content, field hydraulic conductivity, density, and determination of the Munsell colour. Visual test pit logs are recorded as the test pits are developed.

Paste pH test results provide an indication of the current state of acidity in the samples, while the paste conductivity test results provide an indication of the total soluble solids associated with the sample. These tests indicate whether oxidation and / or accumulation of leachable contaminants have occurred in the potential cover or waste material. Materials with low pH and high conductivity generally are not considered adequate cover material. Paste pH / paste conductivity tests are not a substitute for a proper geochemical characterization programme; however, in concert with standard field observations during a site investigation (e.g. colour, lithology, sulphide contents, evidence of

oxidation of secondary mineralogy, vegetation, venting, seepage and / or surface water quality, and fish and biota conditions), they are a good indicator of which samples should be submitted for further detailed geochemical testing. The paste pH / paste conductivity testing procedure, adapted from British Columbia AMD Task Force (1989), is outlined as follows.

- 1) Calibrate pH and conductivity or TDS meters using the standard solutions and following instructions provided with the meters.
- 2) Obtain approximately 25 g of fines (particles smaller than 1 mm if possible) from the sample to be tested, and place in a fresh or decontaminated beaker or testing container.
- 3) Add approximately 25 mL of distilled water to the sample. (More water may be required if the sample is very dry or extremely fine).
- 4) Stir the sample with a fresh or cleaned spatula to form a paste or slurry. The paste should easily slide off the spatula.
- 5) Tip the testing container to one side to allow a pool of water or slurry to collect in the corner. Dip each of the probes into the slurry, and allow the meter readings to stabilize. The conductivity reading, however, should be done first, as electrolyte from the combination pH probe may affect the conductivity of the solution.
- 6) Decontaminate the probes and containers.
- 7) Record the measurements in a field notebook along with a description of the rock type tested, and the general appearance of the sample.

A measurement of the *in situ* moisture profile near the ground surface within the existing mine waste is useful in later numerical analyses. The gravimetric moisture content is an indicator of the *in situ* pore-water pressures and water flow through the unsaturated zone. The procedure to determine the gravimetric water content is documented in ASTM 2216-92 (ASTM, 1992a), which defines the water content as the mass of water within the sample divided by the dry mass of the sample. A scale is used to determine the “wet” mass of the sample before it is dried in an oven at 110°C for 12 – 18 hours. The sample is weighed again to determine the mass of water within the sample and the dry mass of the sample.

Field measurements of hydraulic conductivity can be obtained with a constant head well permeameter (e.g. a Guelph permeameter), as shown in Figure 2.4. Determination of field hydraulic conductivity is fundamental because secondary structures in soil (e.g. cracks, worm holes, root channels, etc.) can provide the dominant flow path in fine-textured materials. Hence, the development of a soil structure will strongly influence the hydrological properties of fine-textured cover materials (Meiers *et al.*, 2003). Freeze-thaw and wet-dry cycles, as well as biological activity all contribute to soil structure development. Vegetative and biological activities have the greatest impact on near surface hydraulic conductivity. Wet-dry and freeze-thaw cycles can have a significant impact on the hydraulic properties of cover materials at significantly greater depths. Field hydraulic

conductivity measurements are a single point measurement. To determine a representative value for a material, it is important to do a number of measurements over a representative area. The Equity Silver case study described in Volume 5, describes a spatial evaluation of field hydraulic conductivity and the *in situ* data interpretation to determine representative values.

The Munsell colour chart is a standardized means of recording the material colour used in the classification of the material. Munsell soil colour charts are commercially available and provide a colour code and a colour name. A record of the visual characteristics of the test pit is completed in the test pit log. Characteristics such as the material texture, relative moisture content, gradation, and structure are noted. Digital photos should also be taken as part of the test pit logging exercise.



**Figure 2.4** Field hydraulic conductivity testing.

### **3 LABORATORY CHARACTERIZATION PROGRAMME**

A comprehensive laboratory test programme for the design of cover systems over reactive mine waste will consist of a geotechnical and geochemical component.

#### **3.1 Recommended Geotechnical Testing Programme**

The geotechnical laboratory test programme is generally completed on both the potential cover material and mine waste material samples. The programme is designed to determine the physical and hydraulic parameters required as input to the numerical analysis of soil-atmosphere fluxes and seepage. A comprehensive geotechnical characterization programme would consist of laboratory tests to determine the following parameters:

- Particle size distribution (PSD);
- Atterberg limits (note that X-Ray diffraction (XRD) testing may be required in some cases);
- Specific gravity;
- Compaction curve (i.e. Proctor curve);
- Saturated hydraulic conductivity;
- Consolidation-saturated hydraulic conductivity relationship; and
- Soil water characteristic or moisture retention curve.

Some of the tests, such as PSD and Atterberg limits, are well known and completed by almost all geotechnical engineering testing firms. Other tests, such as the hydraulic conductivity and moisture retention tests are specialized and performed by only a limited number of laboratories. A brief description of the various geotechnical laboratory tests is provided below.

##### *3.1.1 Particle Size Distribution Test*

The particle size analysis testing procedure is detailed in ASTM D422-63 (ASTM, 1990). The PSD test is universally used in the engineering classification of soils (Bowles, 1992). The results of the PSD tests, in combination with the field characterization and logging, allows classification of the potential cover materials under the broad categories of topsoil, well-graded, clay, and coarse materials.

The distribution of grain sizes larger than 75  $\mu\text{m}$  (retained on the No. 200 sieve) is determined by sieving, while a sedimentation process using a hydrometer determines the distribution of grain sizes smaller than 75  $\mu\text{m}$ . The standard sieve test involves passing approximately 500 g of oven-dried (110°C) soil through a series of sieves and then recording the mass retained on each sieve.

The standard hydrometer test involves the use of a specially designed hydrometer to measure the density of a soil in suspension in water at various time intervals. A known mass (approximately 50 g) of oven-dried (110°C) soil passing the No. 10 (2.0 mm) sieve is placed in a 250 ml beaker. Approximately 125 ml of a dispersing agent solution is then mixed in with the soil sample in order to control particle coagulation. After the specimen soaks for at least 16 hours, the sample is dispersed further using a mechanically operated stirring device (i.e. a blender). Immediately after dispersion, the soil-water slurry is transferred to a glass sedimentation cylinder and distilled water is added until the total volume is 1000 ml. After manually agitating the contents of the sedimentation cylinder for approximately one minute, hydrometer readings and the temperature of the suspension are recorded at various time intervals over a 24-hour period. ASTM (1990) provides the relationship for computing the grain size and corresponding percentage of soil remaining in suspension, based on the above measurements. The suspension is transferred to a No. 200 sieve and washed with tap water until the wash water becomes clear after recording the final hydrometer reading. The material retained on the No. 200 sieve is subsequently oven-dried (110°C) and then analyzed by a sieve test.

### 3.1.2 *Atterberg Limits*

The Atterberg limits tests, documented in ASTM D4318-95a (ASTM, 1995), measures the liquid and plastic limit of the soil sample. The limits are primarily used for soil identification and classification. Correlations between the Atterberg limits and soil strength and volume change have also been extensively investigated. The liquid limit has been defined as the water content at which a soil sample placed in a cup with a 12.7 mm groove through its center will close with 25 – 10 mm drops in the measurement device. The plastic limit is arbitrarily defined as the water content at which a soil thread crumbles when it is rolled down to a diameter of 3 mm.

### 3.1.3 *Specific Gravity Test*

The procedure for conducting a specific gravity test on a soil sample is specified in ASTM D854-92 (ASTM, 1992b). A known mass of oven-dried (110°C) soil, approximately 50 g, is placed into a calibrated pycnometer (volumetric flask). The pycnometer is then filled with distilled water to a level slightly above that required to cover the soil. After soaking the specimen for 12 hours, the entrapped air is removed by boiling the contents of the pycnometer for at least 10 minutes. The contents are then subjected to a vacuum for at least 30 minutes by connecting the pycnometer directly to a vacuum pump. After filling the pycnometer to the calibration mark with distilled water, the mass and temperature of the contents of the pycnometer are measured. ASTM (1992b) provides an equation for computing specific gravity based on the above measurements.



### 3.1.4 *Compaction (Proctor) Test*

The compaction test, also known as a Proctor test, is detailed in ASTM D698-91 (ASTM, 1991). The compaction test defines the moisture content–density relationship of a soil sample. This is widely used in construction to produce soils with their maximum unit weight for greatest soil strength. A soil sample is placed into a standard compaction mould in three lifts. At each lift, the material is compacted into the mould using a 24.5 N rammer being dropped 25 times from a height of 0.305 m. The density of the material within the 944 cm<sup>3</sup> mould is calculated from the measurement of the sample mass. A measurement of the gravimetric water content of the sample is completed to compute the dry density of the material sample. This procedure is carried out at a minimum of three water contents to define the relationship between density and water content. Variations of the Standard Proctor test are the Modified Proctor test (ASTM D1557-01, ASTM, 2003), and the Reduced Proctor test. The Modified Proctor uses a larger mould and increased compaction energy, whereas the Reduced Proctor uses less overall compaction energy than the Standard Proctor.

### 3.1.5 *Saturated Hydraulic Conductivity Test*

The saturated hydraulic conductivity of the fine-textured potential cover and mine waste materials is generally measured using a constant head triaxial permeameter apparatus (Figure 3.1). The triaxial permeameter shown in Figure 3.1 was specially designed for low-gradient permeability testing applications (Yanful *et al.*, 1990; Wong and Haug, 1991). The system consists of a triaxial cell, control panel, and data-acquisition system. The lines and fittings for flow in and out of the sample are constructed from high-grade stainless steel, in order to resist the effects of various reactive permeants.

Pressures required for hydraulic conductivity testing are obtained from a central (dried and filtered) air pressure source. The pressure is directed to three fluid reservoirs through a system of regulators on the control panel. The regulators control the inflow, outflow, and confining pressures applied to the sample. The reservoirs are constructed of Lucite to prevent corrosion and to allow visual observation of the effluent test fluid. Gauges on the control panel measure the coarse pressure readings, while the fine adjustments are recorded electronically on the data acquisition system. Twin, double-tube volume-change burettes located between the reservoir and the sample measure flow in and out of the sample to the nearest 0.01 ml.

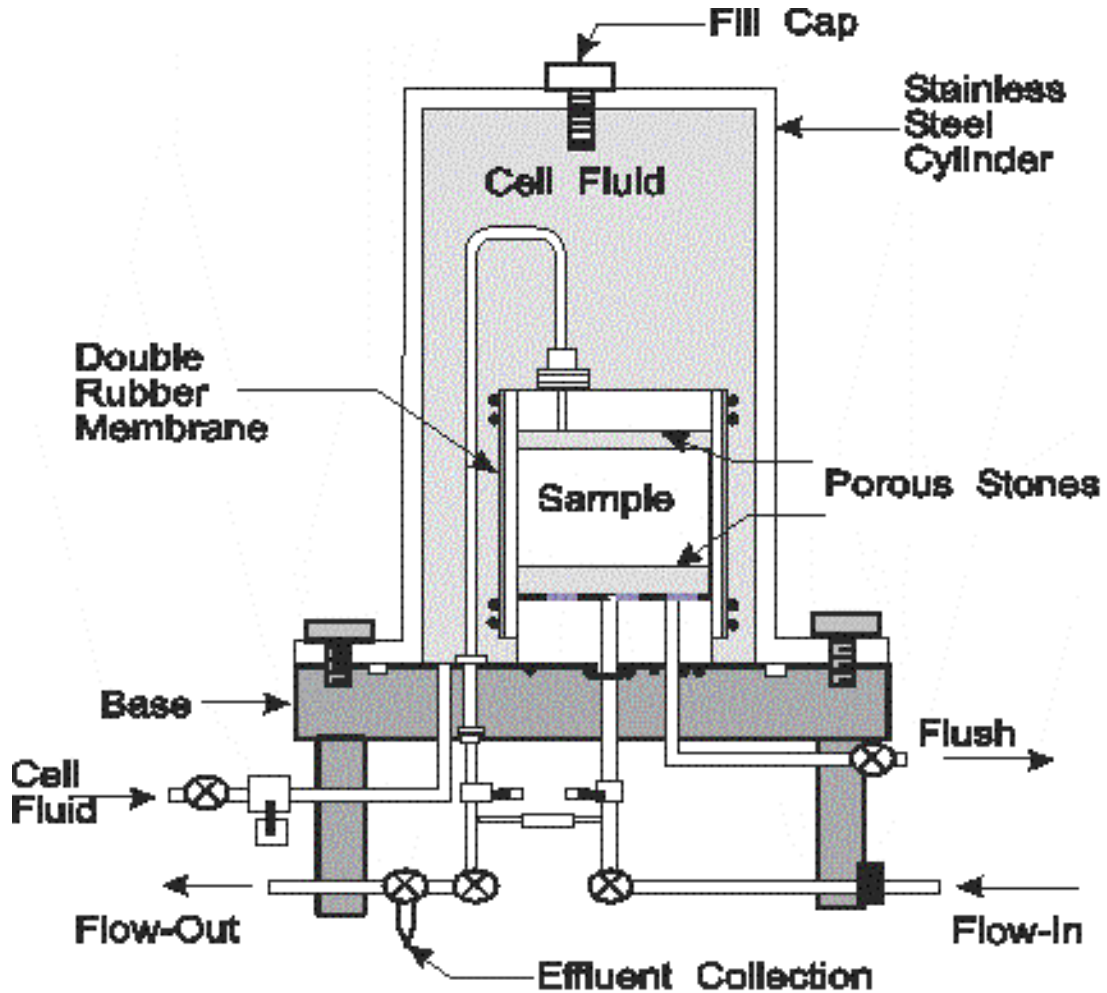

**Figure 3.1** Schematic of a constant head permeameter apparatus.

Permeant is supplied under pressure to the bottom of the sample and exits the top under a backpressure. A confining pressure applied to the sides of the sample minimizes sidewall leakage along the outside surface of the sample. The hydraulic gradient during testing is controlled by adjusting the difference between the inflow and outflow pressures; however, the hydraulic gradient is also a function of the sample height. Low gradient and confining pressure testing produces only slight changes in stress across the sample, minimizing consolidation and artificially low hydraulic conductivity readings (Wong and Haug, 1991). The main disadvantage of low hydraulic gradients is that the total flow through the sample may be small, and thus the precision of the hydraulic conductivity measurements is decreased under these conditions.

A number of techniques are available to offset the precision losses associated with low gradient hydraulic conductivity testing. These involve calibration tests where a solid aluminium cylinder is substituted for a soil sample, and apparent flow rates are recorded on the burettes for different pressure configurations. These leakage values can then be applied as a correction to the measured flow rates during the actual hydraulic conductivity tests. The results of this analysis and adjustments

indicate that the accuracy of these permeameters is approximately 25%, for a hydraulic conductivity of  $1 \times 10^{-10}$  m/s. In addition to leakage corrections, it may also be possible to increase the diameter of the test specimen, effectively increasing the area over which flow is taking place. It may also be possible to increase the precision of the burettes used to measure flow into and out of the sample.

The density conditions (i.e. void ratio) for the test specimens will depend on the estimated or measured field conditions. The objective is to evaluate the change in saturated hydraulic conductivity between each sample, as well as for differing initial density conditions, to ensure that the soil-atmosphere cover design modelling accounts for these effects during sensitivity analyses. The initial moisture conditions for the test specimens are based on field measurements obtained during the site visit.

### 3.1.6 Consolidation-Saturated Hydraulic Conductivity Test

Consolidation-saturated hydraulic conductivity testing is carried out in order to determine the relationship between effective stress, void ratio and saturated hydraulic conductivity for fine-textured potential cover or waste materials samples.

The consolidation portion of this test is performed in accordance with ASTM D2435-96 (ASTM, 1996). The test specimens are slurried with distilled water to an over-saturation condition and placed into a stainless steel oedometer ring, which has an inside diameter of 64 mm and a height of 32 mm. A steel mesh and filter paper are placed above and below the sample in the oedometer ring to prevent the loss of material during the test. The oedometer ring is then placed on the base plate of a modified oedometer apparatus.

The modified oedometer apparatus, illustrated in Figure 3.2, was developed for the measurement of both volume change and saturated hydraulic conductivity. Vertical loading of the sample is provided through a standard consolidation-loading frame. The oedometer ring and base plate are sealed using a rubber O-ring. The base is connected to calibrated burettes using a system of valves that are connected either to a falling head hydraulic conductivity test system or to permeant reservoirs.

Vertical consolidation pressures are generally applied to the sample using a load-increment ratio of one, with a minimum load duration of 24 hours. After each loading and unloading, a falling head hydraulic conductivity test is performed.

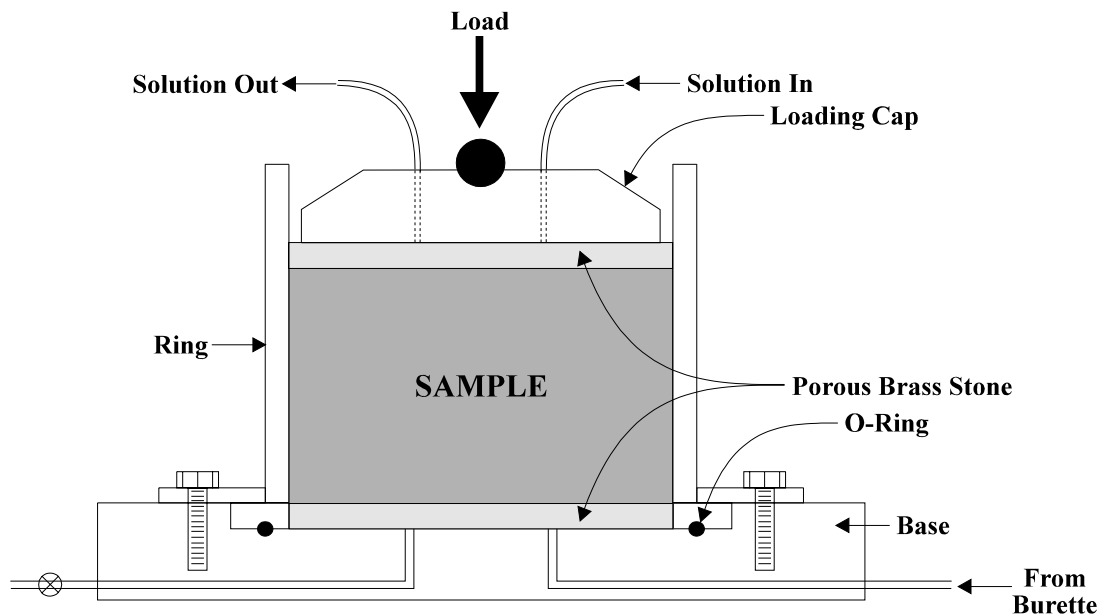

**Figure 3.2** Schematic of a modified oedometer apparatus (after O’Kane, 1996).

The falling head hydraulic conductivity test is performed using a graduated burette to supply water to the sample. The changing head in the burette over time is used to calculate the hydraulic conductivity using the following formula (O’Kane, 1996):

$$k = -\ln\left(\frac{H_1}{H_2}\right) \times \left(\frac{1}{(t_1 - t_2)}\right) \frac{aL}{A}$$

where,

- k = hydraulic conductivity (cm/s),
- $t_1, H_1$  = height of distilled water in the burette at elapsed time  $t_1$  (s),
- $t_2, H_2$  = height of distilled water in the burette at elapsed time  $t_2$  (s),
- a = cross sectional area of the graduated burette (cm<sup>2</sup>),
- L = height of the specimen (cm), and
- A = cross sectional area of the specimen (cm<sup>2</sup>).

### 3.1.7 Soil Water Characteristic Curve Test

A key component of the laboratory programme is the measurement of the moisture retention or soil water characteristic curve (SWCC). The SWCC describes the water content of a material as a function of soil suction, or negative pore-water pressure. The SWCC is central to the design of an

unsaturated soil system, such as a cover system, and is the most fundamental characterization test required for design.

The SWCC is obtained in the laboratory by the axis-translation technique using a pressure plate apparatus and through the use of vapour extraction techniques (ASTM D6836-02, ASTM, 2003). A schematic of the soil water characteristic curve test apparatus is shown in Figure 3.3. The high air-entry ceramic disk of the pressure plate cell is saturated at the start of each test, before the specimen is mounted onto the base of the pressure plate cell. A saturated high air-entry ceramic remains saturated for applied suctions lower than the air-entry value of the ceramic disk (i.e. a 100 kPa air-entry value ceramic disk will remain saturated at suctions up to a maximum of 100 kPa). A saturated ceramic disk is impervious to air flow; however, air can diffuse slowly through the water in the ceramic and air bubbles will eventually appear below the ceramic disk. The volume of air that diffuses into the water compartment below the ceramic disk must be accounted for to correctly monitor the amount of water that is driven out of the soil under each applied matric suction condition. The diffused air is flushed from the system on a regular basis.

Matric suction is applied to the soil either by directly pulling on the water phase (i.e. creating a hanging water column and maintaining atmospheric conditions within the apparatus above the high air-entry disk), or by elevating the air pressure in the cell and using the axis translation technique. In either case the difference between the pore air pressure and pore-water pressure is used to calculate the matric suction applied. For reactive materials, it may be necessary to use a non-reactive gas such as nitrogen in place of air to avoid oxidation of the material during the test.

In general, matric suction is applied by directly pulling on the water phase for matric suction values below 10 kPa. A water column is used for extracting water directly from the soil. A water column provides good accuracy for small suction values. Long flexible tubing is attached to the outlet located at the base of the pressure plate cell. The flexible tubing is filled with water to form a continuous water phase to the ceramic plate and the soil. A negative water head (i.e. matric suction) is applied to the soil specimen by maintaining the water level in the flexible tubing at a specified distance below the specimen. The inlet at the top of the pressure plate cell is vented to the atmosphere to ensure that the air pressure inside the cell is atmospheric. Water draining from the soil specimen is collected in a vented glass vial. Matric suction equilibrium is established in the soil specimen once water ceases to drain from the soil and the mass of the apparatus is constant. The outlet elevation is then lowered to provide an incremental increase in matric suction onto the base of the sample. The process is repeated using the hanging water column for each matric suction increment up to a matric suction value 10 kPa.

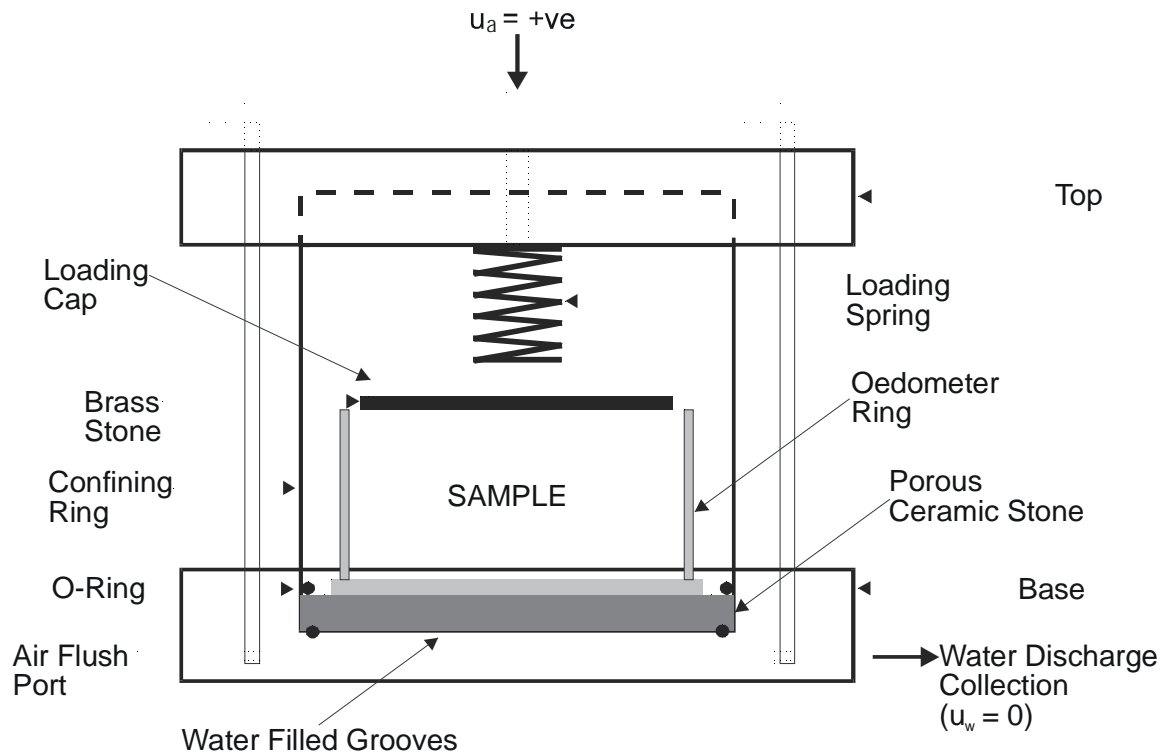

**Figure 3.3** Schematic of a soil water characteristic curve testing apparatus.

The test can be extended to higher levels of suction using the axis-translation technique. The test cell is sealed and a pressurized air supply is connected to the cell. An air pressure regulator with accuracy in the range of 0.5 kPa is used to regulate the pressure to the pressure plate cell. The air is supplied to the pressure plate cell through the air pressure inlet located at the top of the pressure plate cell. The water drainage outlet located at the base of the pressure plate cell is maintained at atmospheric pressure conditions. Water draining from the soil specimen as a result of the applied air pressure is collected in a vented glass vial. Matric suction equal to the applied air pressure is established in the soil specimen when water ceases to drain from the soil and the mass of the apparatus was constant. The next matric suction increment is then applied by raising the air pressure. The process is repeated for each required matric suction value.

The volume-mass properties of the soil specimen are determined at the completion of the pressure plate test. The volumetric and gravimetric water content of the soil specimen corresponding to each matric suction increment are computed from the volume-mass data obtained at the end of the test, by accounting for the amount of water that was lost from the soil at each applied matric suction value.

Large-scale moisture retention tests (30 cm diameter cells) are conducted on coarser textured materials to ensure that a representative particle size range is measured and density conditions encountered in the field are replicated in the laboratory.

The method of applying suction and changing the water content of the sample over suction values greater than 1500 kPa relies on removing the water from the sample as vapour. Small samples are obtained from each of the soil specimens in the soil water characteristic curve tests after reaching equilibrium at the final matric suction increment inside a pressure plate apparatus. A saturated salt solution is placed in the base of the equilibrium chamber. The small soil samples are placed in the vapour equilibrium chambers above the saturated salt solutions. The chamber is sealed to allow the sample to come into equilibrium with the atmosphere created by the saturated salt solution. The mass of the sample is recorded periodically until the sample mass is constant. The total suction is calculated using the Edlefsen and Anderson (1943) formulation after the water content of the soil sample comes to equilibrium in the chamber. Temperature has a significant effect on the humidity of saturated salt solutions and must be monitored. A temperature of 20°C is typically used for the vapour equilibrium test. Table 3.1 summarizes the equivalent total suctions measured on selected samples.

**Table 3.1**

Summary of saturated salt solution humidity and equivalent total suction (from Young (1967)).

Salt	Temperature (°C)	Relative Humidity (%)	Equivalent Total Suction (kPa)
Lithium Chloride ( $\text{LiCl}_2 \cdot \text{H}_2\text{O} + \text{LiCl}_2 \cdot 2\text{H}_2\text{O}$ )	20	11.5	$2.93 \times 10^5$
Magnesium Chloride ( $\text{MgCl}_2 \cdot 6\text{H}_2\text{O}$ )	20	33.0	$1.50 \times 10^5$
Magnesium Nitrate ( $\text{Mg}(\text{NO}_3)_2 \cdot 6\text{H}_2\text{O}$ )	20	54.3	$8.26 \times 10^4$
Sodium Chloride (NaCl)	20	75.5	$3.80 \times 10^4$
Potassium Sulphate ( $\text{K}_2\text{SO}_4$ )	20	97.0	$4.12 \times 10^3$

### 3.2 Recommended Geochemical Testing Programme

A detailed geochemical testing programme is generally performed on samples of reactive mine waste to determine the current and potential long-term geochemical characteristics of the waste material. Geochemical laboratory tests, such as paste pH and conductivity analyses, would generally be performed on potential cover material samples to ensure that the material is suitable for use in the cover system design.

This section is included for completeness of this document, and is not meant to be a comprehensive discussion of a geochemical characterization programme. The reader should consider the documents referenced in each particular sub-section for further details.

A comprehensive geochemical characterization programme would consist of the following laboratory tests:

- Paste pH and conductivity analyses – largely to serve as QA/QC for field measurements;
- Modified Acid Base Accounting (ABA) tests – which consist of total sulphur analyses and acid neutralization capacity titrations;
- Static Net Acid Generation (NAG) tests – which together with the results of the ABA tests provide a refined classification of the potential for acid generation;
- Kinetic Net Acid Generating (NAG) tests – if a better understanding of the time dependent oxidation processes are deemed necessary;
- Leach extraction tests – to provide an indication of the pore-water chemistry and soluble content associated with the samples;
- Forward acid titration tests (also termed acid buffering characteristic curves) – to provide an indication of the pH ranges in which buffering is available; and
- Multi-element ICP whole rock analysis – to provide an assessment of the heterogeneity of the materials.

An additional test that may be performed is the measurement of the oxidation rate of the material. This can be done using an oxygen consumption cell in the laboratory or in the field using an oxygen consumption test.

Brief descriptions of the recommended geochemical laboratory tests are given below.

### *3.2.1 Paste pH and Conductivity*

The objectives of these tests are to determine the pH and conductivity of the pore-water resulting from dissolution of secondary mineral phases on the surfaces of oxidized rock particles, and to indicate whether oxidation, and accumulation of contaminants in the form of secondary mineral phases, has occurred in the waste rock prior to collection of the sample. The procedure was outlined under field testing methods in Section 2.3, and will not be re-stated here.

High conductivity (or TDS) levels indicate there is considerable store of contaminant salts. These are usually sulphates, but can be other metal salts. When a sample is collected over depth, it is not always clear whether the stored salts are due to oxidation at that point in the sediment profile, or if the salts were generated somewhere higher in the profile due to evapoconcentration and moved downwards to the sample location. Stains along the flow path may indicate if this is the case.

Low pH readings indicate oxidation and acid generation and / or accumulation of oxidation products has occurred, usually at the location from which the sample was collected. Readings taken on



uncrushed samples in the field or laboratory provide a much better indication of the extent of oxidation as compared to crushed samples.

Additional detail can be found on these tests in Sobek *et al.* (1978), British Columbia AMD Task Force (1989) and MEND 1.16.1b.

### 3.2.2 *The Modified Acid Base Accounting (ABA)*

The objective of this test is to determine the balance between acid producing and acid consuming components of mine waste. The fundamental principles of the acid base accounting comprise two distinct measurements:

- Determination of the neutralization potential (NP) of a sample; and
- Calculation of the acid potential (AP) of the sample.

The difference between the two values, the net neutralization potential (Net NP), and the ratio (NP:AP) allow classification of the sample as potentially acid consuming or producing. To facilitate comparison of values, NP, AP and Net NP are typically expressed in units of kg CaCO<sub>3</sub> equivalents per tonne.

In the original Sobek method of acid base accounting, heating the sample and mixing for two hours determined the neutralization potential. In the modified method, the neutralization potential is determined by treating a sample with excess standardized hydrochloric acid at ambient, or slightly above ambient (25-30°C), temperatures for 24 hours. A fizz test is employed to provide a guide to the amount of acid to be initially added to the test. Acid is added as required during the acid-treatment stage to maintain sufficient acidity for reaction. After treatment, the unconsumed acid is titrated with standardized base to pH 8.3 to allow calculation of the calcium carbonate equivalent for the acid consumed.

For the calculation of the acid potential, the sample is analyzed for total sulphur and sulphate sulphur, and sulphide sulphur is calculated by difference. AP is determined from the calculated sulphide sulphur analysis, assuming: 1) total conversion of the sulphide to sulphate; and, 2) production of four moles H<sup>+</sup> per mole of sulphide oxidized assuming that all the sulphide is present as pyrite. In some cases, difficulties associated with the analytical procedures for sulphide analysis may influence the estimation of the acid generation potential. For example, sulphate associated with the mineral barite is not readily distinguished from sulphide in a typical sulphate analysis, and does not contribute to the acid potential.

Additional information on this test can be found in Lawrence and Wang (1997), Sobek *et al.* (1978), MEND 1.16.1a, and MEND 1.16.1b.

### 3.2.3 Static Net Acid Generation (NAG) Test

This test determines the net acid producing potential of a sample and is used to refine the results of the theoretical ABA predictions. The sample is oxidized with hydrogen peroxide to completely oxidize all acid producing material. The acid formed is allowed to react with the neutralizing potential. The net remaining acid is determined by titration with sodium hydroxide to neutral pH. The amount of NaOH needed is equivalent to the NAG of the material (expressed in kg H<sub>2</sub>SO<sub>4</sub>/tonne material).

The NAG capacity is an independent measure of the acid generating potential of a sample. Materials should be classified based on the information summarised in Table 3.2.

**Table 3.2**  
Material classification based on ABA results.

SAMPLE CATEGORY	FINAL NAGpH	NAG VALUE	NNP
		(kg H <sub>2</sub> SO <sub>4</sub> /t)	
POTENTIALLY ACID FORMING			
Higher capacity	<4	>10	positive
Lower capacity	<4	≤10	-
UNCERTAIN <sup>a</sup>	≥4	0	positive
NON-ACID FORMING <sup>b</sup>	≥4	0	negative

<sup>a</sup> Further evaluation including sulphur forms and mineralogy

<sup>b</sup> Acid consuming materials are identified by NNP values less than approximately -100

Additional information on this test can be found in Miller *et al.* (1997), Lewis *et al.* (1997), and MEND 1.16.1b.

### 3.2.4 Kinetic Net Acid Generation (NAG) Test

The objectives of kinetic NAG tests are to simulate weathering behaviour in wastes to predict characteristics such as sulphide oxidation rates, carbonate depletion rates, acid generation lag times, and metal leaching rates. The simplest use of kinetic tests is to confirm the results of static testing, though this is a very limited application. Kinetic NAG tests are typically carried out using humidity cells. Numerous variations on the test procedure for humidity cell testing exist.

Additional information on humidity cells and variations in testing procedures can be found in MEND 1.16.1a, MEND 1.16.1b, and MEND 5.4.2c.

### 3.2.5 Leach Extraction Test

The objectives of this test are to characterize and quantify the soluble contaminant content of waste rock samples.

The sample is mixed with distilled water, and is agitated in a flask to allow dissolution of the contained, soluble secondary mineral phases. The solution is collected at the end of the test, filtered, and analysed for immediate parameters (pH, alkalinity, acidity, sulphate, and conductivity) and for contained metals.

### 3.2.6 Forward Acid Titration (Acid Base Characteristic Curve)

The objective of this test is to determine, qualitatively, the acid neutralizing capacity of a rock sample

The amount of acid required to reach each pH interval is dependent on the amount of neutralizing material available. As the pH decreases, more resistant minerals neutralize the acid. At pH of 7 to 9, less resistant carbonate minerals, such as calcite and dolomite, are the primary neutralizing agents. More resistant carbonates such as siderite ( $\text{FeCO}_3$ ) and magnesite ( $\text{MgCO}_3$ ) are neutralizing components at a pH of 5 to 6, and iron, aluminium and magnesium hydroxides buffer to pH 3.7. Below pH 2, silicate minerals become important buffering minerals.

Additional information on this test can be found in Sobek *et al.* (1978), British Columbia AMD Task Force (1989), and MEND 1.16.1b.

### 3.2.7 Measurement of the Oxidation Rate Coefficient

The objective of these tests is to determine the oxidation reaction rate coefficient ( $k_r$ ) that describes the rate of oxygen consumption in a reactive material. The laboratory method involves placing the material inside a sealed cell, on a perforated plate. The apparatus is flushed with nitrogen to purge any oxygen in the sample pores. A finite oxygen concentration is created in an upper reservoir above the tailings. This oxygen is allowed to diffuse through the tailings. The decreasing concentration in the upper reservoir and the increasing concentration in the lower reservoir are measured with time. The two concentration curves are then used to calculate the diffusion coefficient and the kinetic oxidation coefficient. Details of the apparatus and test method can be found in Aubertin *et al.* (2000).

There are also field tests that can be used to determine the kinetic oxidation coefficient. The oxygen consumption test is based on the decrease in the oxygen concentration with time in the headspace of a chamber placed over the material surface. This method works best with fine-grained materials so that a good seal can be formed between the chamber and the material surface. Once the system has reached steady-state, the rate of oxidation can be determined. The diffusion coefficient must either be known or measured separately to determine the kinetic oxidation coefficient using this method. Elberling and Nicholson (1996) go into detail on this testing method.

## 4 NUMERICAL MODELLING FOR COVER SYSTEM DESIGN

It is important to establish at the outset that the design of a soil cover for mine waste is fundamentally different, in both design rationale and methodology, from the design of a liner for the containment of hazardous waste. In the latter case, the concept of establishing nearly total isolation of the waste through the development of a barrier to water movement is primary and the predominant material behaviour governing performance is to ensure that these extremely low water fluxes are achieved through engineering the construction of an extremely low hydraulic conductivity barrier. The design of a soil cover system is somewhat more complex conceptually. Due to this complexity, both in terms of relevant processes and properties, the performance of various design elements have more flexibility. The primary goal is not isolation, but integration. The cover must provide an interface between the atmosphere and the mine waste which manages the dynamic fluxes of energy, water, and gas in a manner that optimizes the performance over a series of sometimes opposing performance criteria such as minimizing water percolation, sustaining vegetative growth, and minimizing oxygen ingress. Numerical analysis of cover performance is an integral component of design because of the complexity of the relevant processes, the non-linearity of the material properties, and the coupling of soil, vegetation and atmospheric conditions,

### 4.1 Approach to Numerical Modelling

The key issues governing the use and applicability of modelling tools relate to defining the input required for the model and understanding the key output. These issues not only affect the choice of model best suited for the application, but also the site and material information required prior to evaluating the designs.

#### 4.1.1 *Input*

In essence, all models solve a specified set of physics subject to boundary conditions and material behaviour (material properties). The physics describe the processes occurring within the cover system; the boundary conditions set limits on the problem, and the material properties define the behaviour of the cover.

In evaluating cover system performance, the physics that are involved are typically limited to:

- Movement of air: this includes advection and diffusion processes and includes the flow of oxygen or other gases of interest;
- Movement of water: this includes percolation of liquid water (advection) as well as evaporation (movement of water vapour), and transpiration; and
- Solute movement: this includes advective and diffusive movement of contaminants, adsorption and decay, which represents a geochemical reaction such as oxygen consumption.

Not all of these processes are involved in every system. Often, the physics modelled are limited to the movement of air and water.

The coupling of atmospheric and vegetation conditions to the migration of soil moisture requires that the transport of water and heat are coupled and solved simultaneously. Once these fluxes are defined then the coefficient of diffusion can be estimated based on the *in situ* moisture profile, and the oxygen flux can then be calculated.

The simulation of these processes can be undertaken through the solution of what is known as a Boundary Value Problem (BVP) (Freeze and Cherry, 1979). In this type of problem a domain (geometry) is defined in which a solution is required. The governing partial differential equations that describe the phenomena of interest are expressed in terms of the key dependent variables. These governing partial differential equations are then solved as a function of time and space within the domain subject to the boundary conditions applied to the domain and the material properties. The boundary conditions required include the specification of the dependent variables (e.g. total head and temperature) or their derivatives (e.g. fluxes of heat or water) along the external boundary of the domain, and the specification of the initial conditions for the dependant variables within the domain.

The boundary conditions set limits on the problem and force the physical processes to behave in certain ways. The key boundary conditions for cover system modelling are:

- Upper boundary conditions: climate and vegetation;
- Lower boundary conditions: hydrogeology; and
- Initial conditions.

Material properties are usually based on some key measurable properties such as porosity, specific gravity, saturated hydraulic conductivity, and the SWCC.

Once the input has been defined, a method of solution must be chosen. The term “modelling” has become synonymous with commercially available software packages but the method of solution may be analytical or numerical, one-dimensional or multi-dimensional, and can be as simple as a single formula or complex as a three-dimensional finite element model.

#### 4.1.2 Output

The output from numerical modelling is directly related to the cover system performance criteria, which relates back to the cover system objectives. Typically, the key outputs from the numerical model are fluxes: both oxygen and water fluxes.

In general, the output used for determining the preferred cover system design for a particular site may include the predicted net percolation of water and the diffusion of oxygen into the underlying waste. It is important to note, however, that control of oxygen ingress may not be technically or practically

feasible at all sites due to significant dry climate conditions for an extended period of the year. Despite this, oxygen ingress should always be modelled / predicted as part of the cover system design process such that the data can be used during geochemical speciation modelling of the underlying waste.

Finally, in terms of evaluating cover system performance, it is fundamental that the performance of the cover system is “linked” to the predicted sulphate concentrations in the seepage from the waste storage facility and ultimately to the impact on surface water and groundwater. This fundamental concept incorporates the scope of the cover system and provides the necessary rationale for determining the required reduction in net percolation and / or control in oxygen ingress for the cover system.

4.1.2.1 Defining Net Percolation

Net percolation, as shown conceptually in Figure 4.1, is the net flux of meteoric water across the cover-waste interface. Meteoric water will either be intercepted by vegetation, runoff, or infiltrate into the surface. Water that infiltrates will be stored in the “active zone” and the majority of this water will then be returned to the atmosphere through evaporation or transpiration. A percentage of the infiltrating meteoric water will migrate beyond the active zone as a result of gravity overcoming the influence of atmospheric forcing (i.e. evaporation), and this becomes net percolation to the underlying waste.

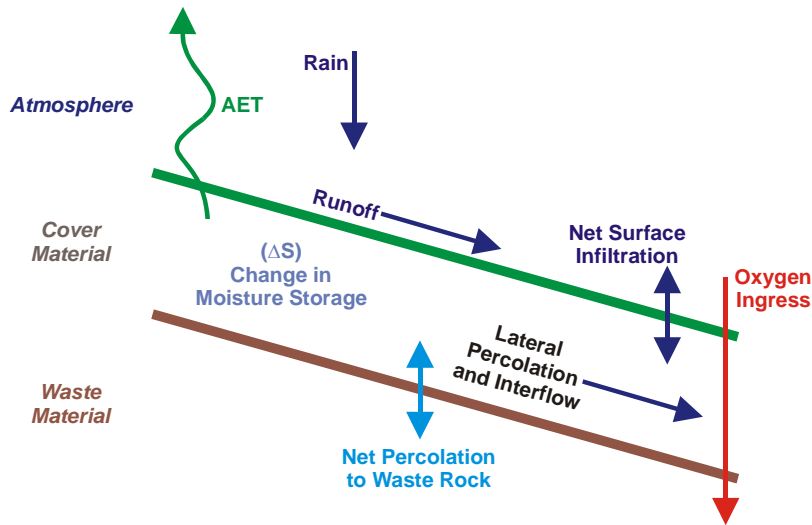

Figure 4.1 Conceptual illustration of net percolation.

## 4.2 Numerical Modelling Methodologies

There are many numerical tools available to aid in the analysis and design of cover systems. Chapuis *et al.* (2001) provide a good summary of unsaturated flow models. The tools have a wide range of capabilities and limitations and the efficacy of the tools is highly dependant on the experience of the user. It is up to the designer to understand the theoretical foundations for each tool and, with a design objective in mind, apply the tool in a methodical way so that there is a reasonable assurance the generated output is representative of “real life” possibilities.

The primary advantage of numerical modelling is not the ability to predict a specific future outcome; rather, it is the advantage that it has to enhance the understanding that the designer has of the processes and how these processes will influence cover behaviour. This allows the designer to compare various design alternatives as to their relative performance and to make a judgement on a preferred option based on their understanding of behaviour.

The purpose for numerical modelling in general is threefold. First, modelling can be conducted to interpret a mechanism or process (e.g. to prove a hypothesis or to “train” our thinking), or to assist with interpretation of field data. Second, modelling can be used to evaluate the relative performance of alternate conditions. And finally, modelling can be used for predicting a final behaviour or impact. In general, the latter two aspects tend to be the focus of numerical modelling, when in fact the first rationale should be the foremost use of a numerical model. For example, numerical modelling is often dismissed as being “useless” due to a lack of predictive accuracy. However, the key advantage to numerical modelling is the ability to enhance judgement, not the ability to enhance predictive capabilities. In short, numerical modelling should focus on improving our ability to understand key processes and characteristics, as opposed to enhancing predictive capability. Numerical modelling should be undertaken at all levels of the project (e.g. data gathering, interpretation, and design), and not just for predicting performance.

A general objective of modelling is to obtain computed data that represents what may *reasonably* happen under a specific set of conditions. Reasonableness however, should not be confused with accuracy or reliability. A computer calculates numbers to the tenth decimal place but this should not imply the prediction is accurate.

It is primarily the knowledge and skill of the user that determines if and when results are reasonable. The most common mistake with numerical modelling is for the user to accept the results without question, without having a fundamental understanding of the physical system being modelled, a theoretical foundation for the model, and the limitations of the model. The most straightforward approach to obtaining reasonable results is to follow a proven methodology.

The key components of a numerical modelling methodology are analogous to the scientific method, or the engineering approach to solving a problem, as shown in Table 4.1.

**Table 4.1**  
Modelling parallels to the scientific method.

<u>Scientific Method</u>	<u>Engineering Approach</u>	<u>Modelling</u>
Observe	Definition of the problem.	Development of the conceptual model.
Measure	What processes are occurring?	Define the theoretical model.
Explain	What does the system involve?	Obtain the numerical model (develop an accurate solution).
Verify	Does the solution agree with measured conditions or intuition?	Resolve the interpretive modelling results (prove the hypothesis, does the interpretive model represent reality, or do you need to change your thinking?)

#### 4.2.1 Purpose and Scope of Cover Design Modelling

The general purpose for conducting cover system design modelling is to gain an understanding for the key processes and characteristics that will control performance. In addition, the cover system design numerical modelling will provide the means to evaluate the conceptual or preliminary design of a cover system for the site waste storage facilities in terms of meeting the cover system design objectives. The cover design objectives may be to buffer percolation into the underlying waste and / or to control the ingress of atmospheric oxygen. A cover system design and analysis might typically consist of one-dimensional soil-atmosphere modelling and two-dimensional saturated-unsaturated modelling.

In general, the objectives of the one-dimensional (1-D) soil-atmosphere modelling are to:

- compare performance of alternate designs (i.e. single layer, multi-layer cover systems, and layer thickness);
- predict the net percolation of moisture to the underlying waste material; and
- evaluate the ability of the alternate cover systems to limit the ingress of atmospheric oxygen to the underlying waste material.

The major limitations of 1-D modelling are the inability of the model to evaluate the performance of covers on a sloping surface or to account for runoff, run-on, and ponding on the cover surface. Therefore, two-dimensional (2-D) modelling is an important step to evaluate the performance of the preferred cover system design.

#### 4.2.2 Application of the Modelling Methodology

The soil-atmosphere modelling methodology presented in this manual includes a preliminary soil-atmosphere modelling stage, a detailed soil-atmosphere modelling stage, and a sensitivity soil-atmosphere modelling stage. Once a cover system has been constructed, whether it is full scale or at



a test scale, field response and predictive modelling should be conducted. This modelling methodology is presented as an example of the tools and methods that can be used to predict model performance. Other models and methods can be just as effective at predicting performance.

The following sections summarize the objectives of the modelling stages.

#### 4.2.2.1 Preliminary Modelling (1-D)

The preliminary modelling can be conducted to determine the proper lower boundary condition (LBC) and thickness of the underlying waste material. The objective is to ensure that the location and magnitude of the LBC does not influence the net percolation or oxygen ingress predicted by the model from the cover material to the underlying waste material.

The preliminary modelling can also be used to:

- verify fundamental processes;
- identify limitations of the model and its application to the problem at hand;
- develop modifications to the model to make it more suitable for the problem;
- identify key input parameters; and
- redefine the laboratory characterization or field characterization programme.

The initial moisture and temperature conditions for subsequent detailed modelling should also be generated during the preliminary modelling component of the project. Successive models can be completed using the end-of-simulation moisture and temperature conditions as the initial conditions for a subsequent model. This approach should be repeated until the change in moisture storage within the cover system is constant, which implies that the initial conditions of the detailed models, while representative of site conditions, did not influence the results of the detailed models. This will allow for a quantitative comparison between the results generated by each of the detailed soil-atmosphere models.

The preliminary modelling should also be used to determine which cover system alternatives had the best opportunity for success, where “success” refers to the ability of the cover system to meet the design objectives, such as reducing net percolation and oxygen ingress. This often involves varying the thickness and layering of the available cover materials. In general, a “synthetic” average climate year and “average” material properties for each cover material and the underlying waste are used during the preliminary modelling stage. The “synthetic” average climate year is obtained by averaging each daily climate input parameter for the entire period of record. For example, rainfall on January 1<sup>st</sup> of the synthetic average climate year would be the average of all January 1<sup>st</sup> data for each year of the available climate record. The objective is to “smooth” the modelling process by

eliminating high rainfall and other extreme climate conditions such that numerical instability and water balance modelling problems are greatly minimized.

#### 4.2.2.2 Detailed Modelling (1-D)

The objective of the detailed modelling is to determine the most reasonable or “average” predicted performance of the cover system with respect to net percolation and oxygen ingress, which would then be used as input to seepage and / or groundwater models. Determining the average performance is seemingly a simple task. For example, the climate year that is close to the average annual precipitation could be chosen to predict the average net percolation from the cover system. However, a word of caution is required with respect to utilizing this approach. The net percolation predicted from the mean or median rainfall record for a given site may not be representative of the long-term “average” performance of a cover system. The magnitude and occurrence of various rainfall events throughout the year, coupled with antecedent moisture conditions, plays a major role in the computation of the net percolation through a cover system. Therefore, evaluating long-term “average” cover system performance using the mean climate year may in fact result in a predicted net percolation that is not representative of the “average” net percolation.

The long-term “average” performance of a cover system should be determined from a statistical analysis of the net percolation predicted for each year of the climate record. The latter methodology accounts for the impact of antecedent moisture conditions, as well as the occurrence and intensity of daily rainfall when determining the long-term “average” net percolation.

Another benefit to the statistical approach is the ability to develop a statistical basis for extreme dry and extreme wet climate years. As with determining the average year, it is fundamentally incorrect to simply model the wettest year on record. That particular year may be the wettest year because of one or possibly two significant short duration high frequency rainfall events. Runoff during these events is significant, which may result in a misrepresentation of a more representative extreme climate condition. Determining the net percolation for each year of record provides the necessary data for calculating net percolation values for different return periods, which can then be used for seepage and groundwater modelling. The same process can also be used for oxygen ingress.

#### 4.2.2.3 Sensitivity Modelling (1-D)

A sensitivity analysis with respect to material properties and climate conditions should be conducted on the most promising alternative(s) to confirm performance for various scenarios. The sensitivity analysis will also allow for the development of an understanding of the impact on performance due to:

- extreme climate conditions;
- long-term climate changes; and

- changes with *in situ* conditions and material properties due to biological, physical, and chemical processes, which will impact on long-term performance.

#### 4.2.2.4 Two-Dimensional Modelling (2-D)

One-dimensional modelling has limitations for simulating sloping surfaces and associated runoff and run-on, ponding, as well as lateral and preferential flow. Sloping surfaces are characteristic of waste rock surfaces, heap leach piles, and tailings dam walls as a result of construction methods and placement configurations. A hummocky cover placement also creates a sloping surface that is not well represented by a 1-D model. Volume 2 – Theory and Background discusses preferential flow in greater detail.

The objectives of two-dimensional modelling are to examine the impact of sloping surfaces on the flow patterns of infiltration for changing cover materials and material thickness. Two-dimensional modelling consists of both steady state and transient analyses. The objective is to ensure that the impact of the slope angle, slope length, properties of the cover and waste materials, as well as site specific climate conditions are properly addressed to ensure that the cover system has not been designed as a 1-D system, and placed into a 2-D condition. The design of a cover system as a 1-D system, which is then placed on a sloping surface in a humid or semi-humid climate, often leads to a “fatal flaw” with respect to *in situ* hydraulic performance (i.e. control of net percolation and / or oxygen ingress). The example modelling in the following sections presents 2-D modelling using the program SEEP/W (Geo-Slope International Ltd., 1999), a finite element saturated-unsaturated flow model. Other programs such as VADOSE/W (Geo-slope International Ltd., 2002), a 2-D soil-atmosphere flux model which has recently been developed, will provide 2-D performance evaluation.

### 4.3 **Demonstration of the SoilCover Model**

The soil-atmosphere model, SoilCover, can be used to evaluate the performance of alternate designs for the cover system. The SoilCover model was developed from the work of Wilson (1990) through MEND, with sponsorship from Placer Dome Inc. and the Natural Sciences and Engineering Research Council (MEND 1.25.1). SoilCover is demonstrated here as an example of a 1-D soil-atmosphere model.

SoilCover is a 1-D finite element model that couples moisture and heat flow in order to simulate pressure head and temperature profiles in the soil profile in response to climatic forcing (GeoAnalysis 2000 Ltd., 2001). A key feature of SoilCover is the ability of the model to predict actual evaporation and transpiration rates based on the potential evaporation and predicted soil suction (Wilson *et al.*, 1994) within the soil profile. The actual evapotranspiration rate is generally well below the potential rate during prolonged dry periods because the suction in the soil profile increases as the surface desiccates. Vapour diffusion in response to both temperature and suction gradients is also

incorporated into the model. This feature is particularly important for evaluating cover system performance in arid climates.

Analysis of the performance of a cover system with a soil-atmosphere model such as SoilCover requires the input of various climatic and vegetation parameters as well as material properties. The SoilCover model requires input of daily precipitation, net radiation, air temperature, relative humidity, and wind speed. Precipitation is often the most critical climate input parameter for analyzing the performance of alternative cover systems. This input parameter has the greatest influence on net percolation, which is typically the output parameter of greatest interest. The predicted average net percolation through the preferred cover system option over the long-term is then used to determine the potential mass flux of contaminants from the waste rock dump over time.

SoilCover utilizes a set of rigorous, physically based equations to simulate moisture and heat flow, however the simulation of transpiration from vegetation is based on an empirical formulation. The potential transpiration rate is based on the leaf area index (LAI). The model user can apply “excellent”, “good”, or “poor” set of default LAI values (which change during the growing season), which have been developed from data on agriculture crops. This is the primary disadvantage of the SoilCover vegetation module when modelling arid climate conditions. The native vegetation has adapted to site conditions and typically has much different transpiration rates as compared to agriculture crops. The ability of the vegetation to transpire at potential rates, as a function of LAI, is then limited by two suction limits; the moisture limiting suction at which transpiration is reduced, and the wilting point at which transpiration stops. The use of suction in limiting transpiration links the vegetation to the physically based formulation used for heat and moisture transfer.

#### 4.3.1 *Modelling Example 1*

An example of a SoilCover analysis is presented in this section for a cover system over waste rock in an arid climate with extreme wet and dry seasons. The cover design consists of a compacted layer with an overlying growth medium layer. Two cover systems are evaluated: a medium quality compacted layer ( $k_{\text{sat}} = 1 \times 10^{-6}$  cm/s), and a high quality compacted layer ( $k_{\text{sat}} = 1 \times 10^{-8}$  cm/s). Historical climate data is available for the site.

##### 4.3.1.1 Preliminary Modelling (1-D)

Preliminary modelling was conducted to determine the proper lower boundary condition (LBC) and thickness of the underlying waste rock. This was done to ensure that the location and magnitude of the LBC did not influence the net percolation predicted by the model from the cover material to the underlying waste rock. This aspect of the preliminary modelling showed that the required thickness of waste rock was approximately 5 m, and that the head boundary conditions at the LBC should be set to 60 kPa suction. The appropriate temperature boundary condition for the LBC was determined to be 20°C.

The initial moisture and temperature conditions for subsequent detailed modelling were also generated during the preliminary modelling. Successive annual models were completed using the end-of-simulation moisture and temperature conditions as the initial conditions for the subsequent year. This approach was repeated until no further changes in moisture storage occurred within the cover system. This established the initial conditions for the detailed models that, while being representative of site conditions, do not influence the results of the detailed models. This allowed for a quantitative comparison between the results generated by each of the detailed soil-atmosphere models.

The preliminary modelling was also used to determine which cover system alternative had the best opportunity for success, where “success” referred to the ability of the cover system to limit the net percolation of meteoric rainfall to the underlying waste rock and control the ingress of atmospheric oxygen.

The preliminary modelling evaluated:

- Variations in the thickness of the growth medium layer, both with and without an underlying compacted layer; and
- Variations in the thickness of the compacted layer.

#### 4.3.1.2 Detailed Modelling (1-D)

Detailed SoilCover modelling was conducted on one alternative cover system comprised of a 0.5 m compacted layer overlain by 2 m of growth medium. Daily climatic data for each year of the climate database was utilized as input conditions and the percolation and oxygen ingress predicted by each model was recorded. The net percolation results are presented in Figures 4.2 through 4.4.

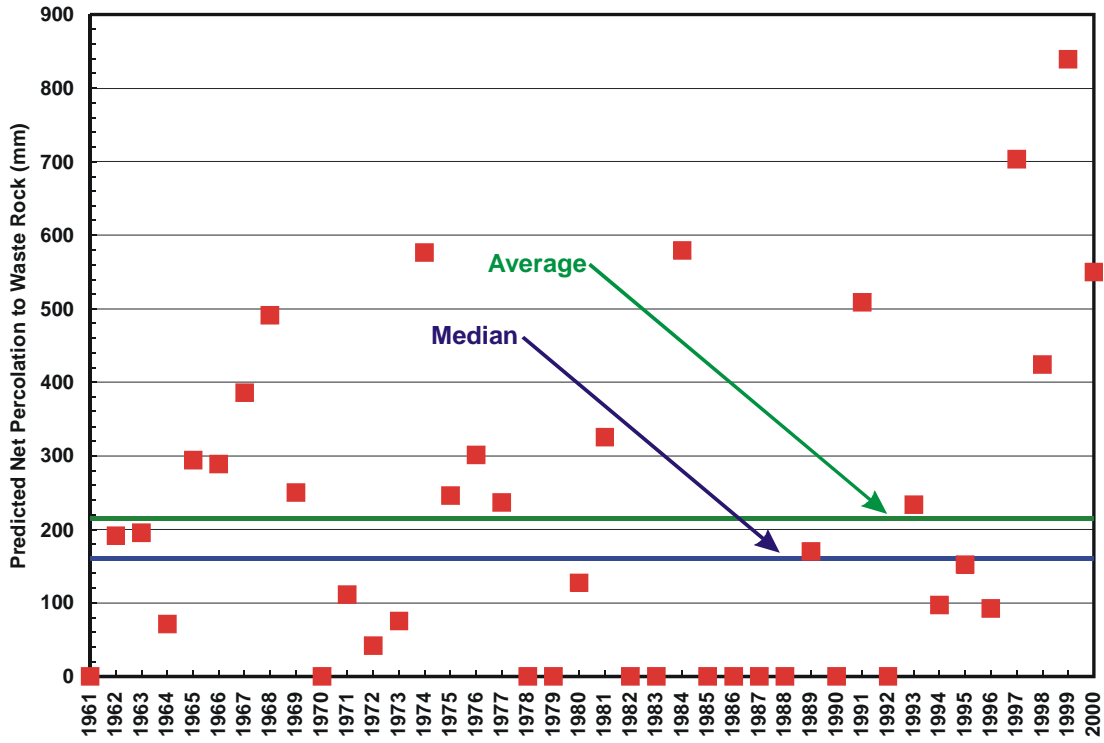

**Figure 4.2** Predicted net percolation from a cover system utilizing moderate quality compacted layer (saturated hydraulic conductivity  $\approx 1 \times 10^{-6}$  cm/s).

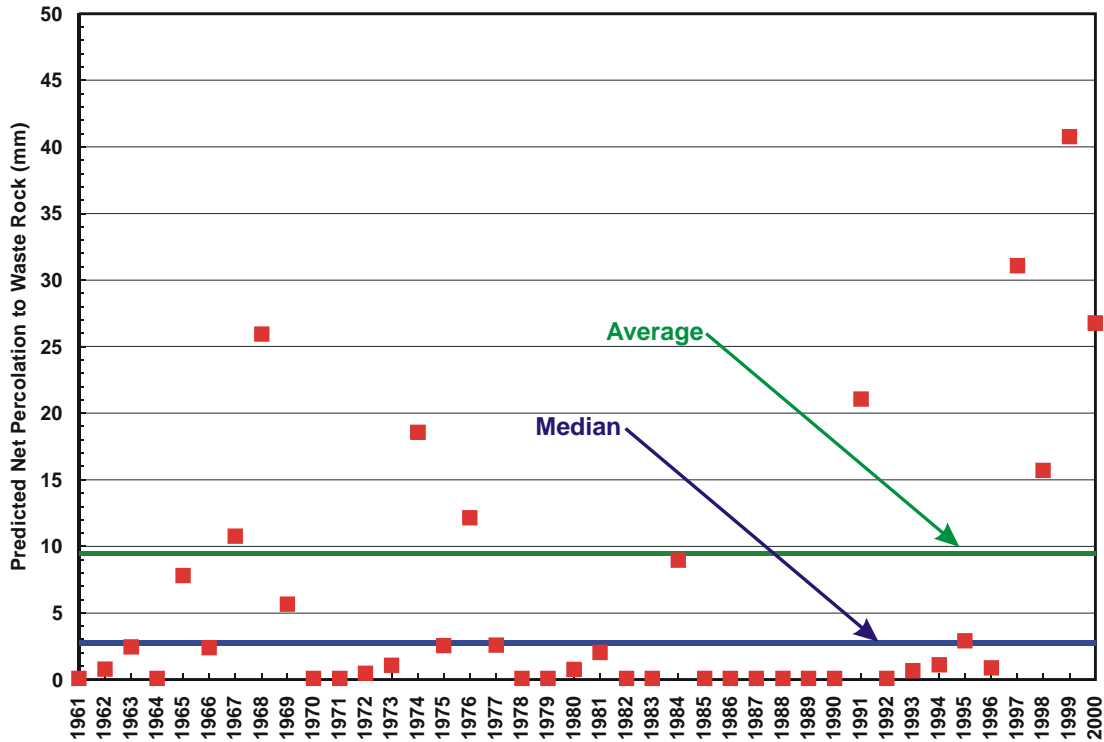
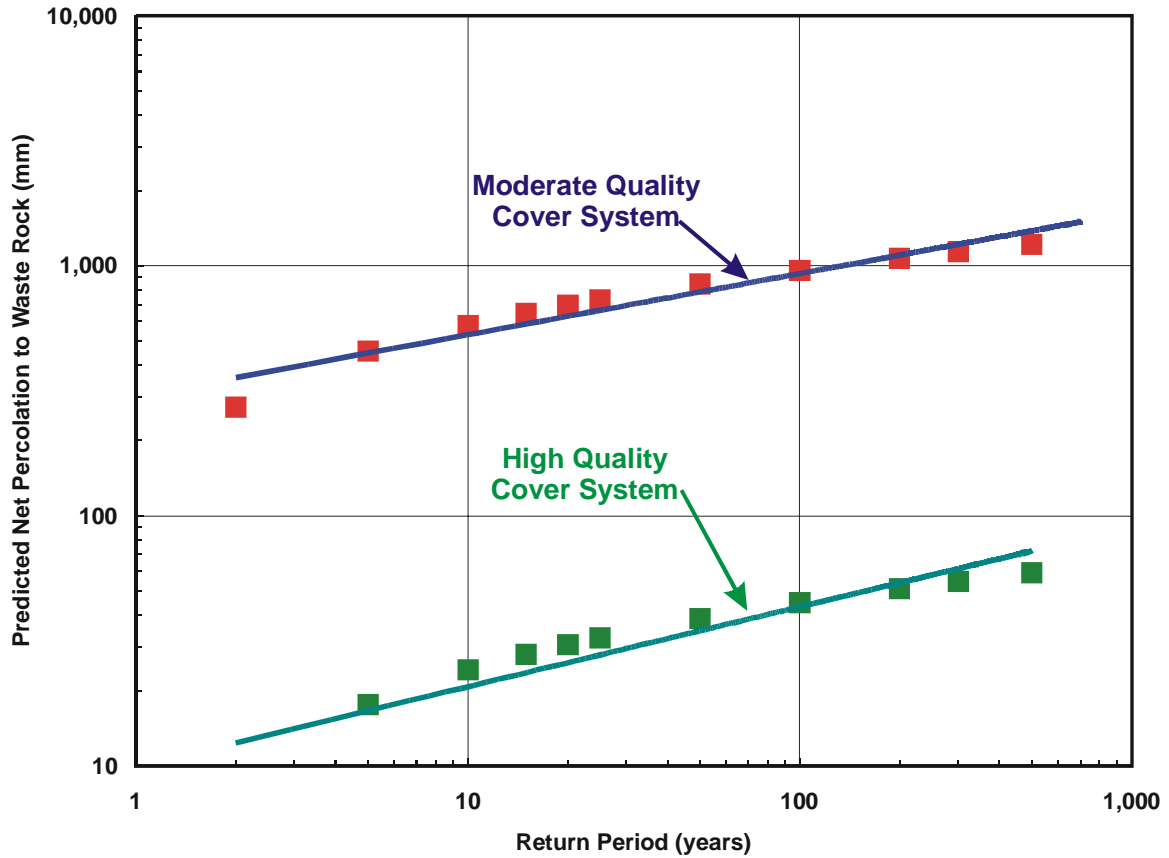

**Figure 4.3** Predicted net percolation from a cover system utilizing high quality compacted layer (saturated hydraulic conductivity  $\approx 5 \times 10^{-8}$  cm/s).

The predicted average and median net percolation for the moderate quality and high quality cover simulations are superimposed on the raw model output shown in Figures 4.2 and 4.3. Note that a net percolation close to 0 mm may be indicative of the year when the model predicted a net upward transport of moisture across the waste material-compacted layer interface. The average and median net percolation predicted for the moderate quality cover system was approximately 215 mm and 160 mm, respectively. This equates to approximately 15% of the average annual rainfall calculated from the site-specific database, and 11% of the site-specific median annual rainfall.

The average and median net percolation predicted for the high quality cover system was approximately 10 mm and 3 mm, respectively. Each of these values equate to less than 1% of the average or median annual rainfall calculated from the site-specific database. These results may not be “predictive” but they do provide an indication of the relative performance of the alternate cover systems to buffer meteoric rainfall from the underlying waste.

Another benefit to the statistical approach is the ability to develop a statistical basis for extreme dry and extreme wet climate years. As with determining the average year, it is fundamentally incorrect to simply model the wettest year on record. That particular year may be the wettest year because of one or possibly two significant short duration high frequency rainfall events. Runoff during these events is significant, which may result in a misrepresentation of an extreme climate condition. Determining the net percolation for each year of record provides the necessary data for calculating net percolation values for different return periods, as shown in Figure 4.4, which can then be used for seepage and groundwater modelling. The data from the analysis presented in Figures 4.2 and 4.3 is presented in Figure 4.4 as return periods for net percolation. A similar plot can also be developed for oxygen ingress.



**Figure 4.4** Predicted return periods of net percolation for the moderate and high quality cover systems.

4.3.1.3 Sensitivity Modelling

Once a base case of input parameters has been established, additional sensitivity simulations can be run in which one input parameter is varied while all others remain constant. A sensitivity analysis for the high quality cover system was completed using the parameters listed in Table 4.2. The net percolation predicted for each of these models is then compared to that predicted for the “base case” simulation (i.e. 10 mm), and the results are presented in Figure 4.5. The range of values used for the input parameters was selected based on the results of the laboratory tests, field characterization and observations, and experience.



**Table 4.2**  
Summary of sensitivity soil-atmosphere cover design model variables.

Model Input	Variation to Model Input
Vegetation Transpiration	<ul style="list-style-type: none"> <li>No vegetation (bare surface)</li> <li>SoilCover default “poor” vegetation</li> <li>Site-specific vegetation</li> </ul>
Vegetation Root Depth	<ul style="list-style-type: none"> <li>Depth of roots to 50 cm (base case = 100 cm)</li> <li>Depth of roots to 100 cm</li> </ul>
Potential Evaporation	<ul style="list-style-type: none"> <li>PE using a pan coefficient = 0.50</li> <li>PE using a pan coefficient = 0.70</li> <li>PE using a pan coefficient = 0.80</li> </ul>
Saturated Permeability of the <i>In Situ</i> Waste Material	<ul style="list-style-type: none"> <li><math>k_{sat} = 5 \times 10^{-3}</math> cm/s</li> <li><math>k_{sat} = 5 \times 10^{-2}</math> cm/s</li> </ul>
Saturated Permeability of the Growth Medium Material	<ul style="list-style-type: none"> <li><math>k_{sat} = 5 \times 10^{-4}</math> cm/s</li> <li><math>k_{sat} = 5 \times 10^{-6}</math> cm/s</li> </ul>
Saturated Permeability of the Compacted Material	<ul style="list-style-type: none"> <li><math>k_{sat} = 1 \times 10^{-7}</math> cm/s</li> <li><math>k_{sat} = 1 \times 10^{-8}</math> cm/s</li> </ul>

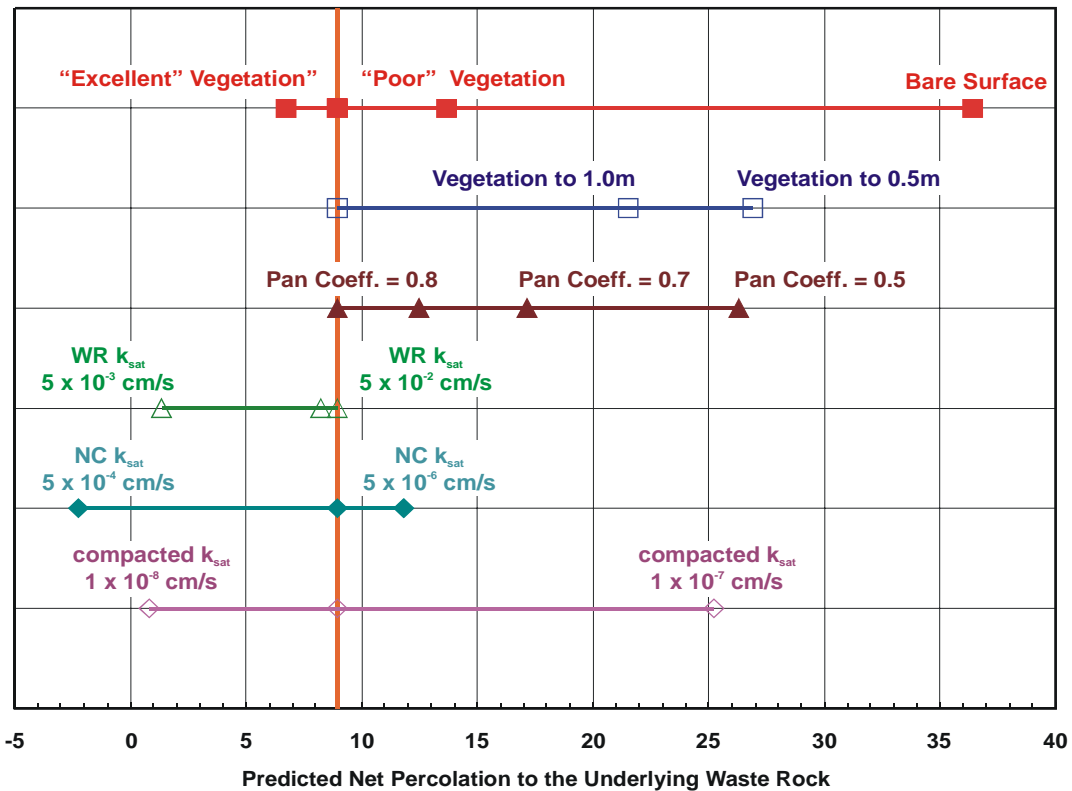

**Figure 4.5** Summary of sensitivity analysis for the high quality cover system.

The results from the sensitivity analysis led to the following observations.

- The assumption of a bare cover surface caused the greatest increase in net percolation. Net percolation was predicted to increase by 4 times for this condition to approximately 36 mm, which equates to approximately 2% of the rainfall modelled for the 365-day simulation.
- Decreasing the saturated hydraulic conductivity by one-order and two-orders of magnitude resulted in a reduction in the predicted net percolation. This is initially counter-intuitive, but it should be noted that the higher saturated hydraulic conductivity of the underlying waste rock increases the contrast at the waste rock-compacted layer interface. Therefore, the ability of the waste rock itself to function as a capillary break layer is enhanced leading to an increase in soil moisture storage within the cover thereby reducing net percolation.
- The base case pan coefficient was 0.9 and was used to reduce pan evaporation measured at the regional meteorological station to representative potential evaporation. The pan coefficient is required because placing a large-scale pan filled with water in an area with a bare surface or a vegetated surface will increase evaporation from the pan. The surrounding aridity influences the microclimate above the water surface such that evaporation from the pan increases as compared to the actual potential evaporation. An evaporation pan will only measure actual potential evaporation if it is located in a large open body of water. The pan coefficient was decreased to 0.8, 0.7, and 0.5 to evaluate the impact on predicted net percolation due to potentially differing vegetation cover. Reducing the pan coefficient also served to determine whether the assumptions made for adjusting the pan evaporation data from the meteorological climate station to represent mine site pan evaporation data influenced the model. In both cases, the model predicted that there was a negligible influence on predicted performance.
- Increasing and decreasing the saturated hydraulic conductivity of the non-compacted growth medium layer by one-order of magnitude had little impact on the predicted net percolation. In fact, a net upward movement of moisture was predicted for the case when the non-compacted layer was increased by an order of magnitude. Again, this result is counter-intuitive, but is in reality quite reasonable. Increasing the saturated hydraulic conductivity does increase surface infiltration as well as vertical percolation due to gravity. However, following infiltration events, the increase in hydraulic conductivity also provides for more moisture migration to points at which moisture can be released through evaporation or transpiration. In short, while it is “easier” for percolation to occur towards the waste rock due to the higher hydraulic conductivity, it is also “easier” for the percolation to move upward as exfiltration in response to atmospheric forcing (i.e. evaporation and transpiration).
- Increasing and decreasing the saturated hydraulic conductivity of the compacted layer by one-half order of magnitude had little impact on predicted percolation.

### 4.3.2 *Modelling Example 2*

This section demonstrates the use of SoilCover to examine the performance of various cover system designs under different climatic conditions. This illustrates the influence of three different climate types (semi-arid, seasonally humid, humid) on three different cover system designs (moisture store-and-release, low hydraulic conductivity compacted barrier, capillary break). The exercise will evaluate the suitability of each cover design in reducing the amount of oxygen and water percolating into the waste material profile.

#### 4.3.2.1 Description of Simulated Climate Conditions

##### *Semi-Arid Climate*

A climate is considered to be arid or semi-arid when the average annual potential evaporation at the site is greater than the average annual precipitation. The semi-arid climate conditions used in this exercise were adapted from a mine site in the interior of southern Australia. The annual precipitation is 466 mm while the annual potential evaporation is 2200 mm. The average maximum temperature ranges from 34°C in January to 16°C in July. The precipitation events are fairly spread out during the year with no clearly defined “wet” or “dry” season, however, historical records at the site show that January usually receives the greatest average rainfall (57 mm) while June receives the least (24 mm). Precipitation often falls during intense storm periods that feature high amounts of precipitation over a short time frame.

The climate conditions at this site would be representative of summer conditions at numerous mine sites in Canada.

##### *Seasonally Humid Climate*

The climate is considered to be humid when the average annual precipitation is close to or greater than the average annual potential evaporation. The climate is described as seasonal when there are clearly defined wet and dry seasons. The seasonally humid climate conditions used in this exercise were adapted from a mine site in northern Australia. The climate at the site is strongly seasonal and highly variable, ranging from heavy cyclonic rainfall to drought conditions. Mean annual rainfall is approximately 1,350 mm and 90% of this occurs during the months of November to March, inclusive. Maximum daily temperatures are generally quite consistent throughout the year, ranging between 28°C and 33°C. The annual precipitation of the climate year used in this exercise is 1458 mm and the annual potential evaporation is 2497 mm.

The climate conditions at this site would be representative of conditions at numerous mine sites in Canada; with the exception that the “wet” season be replaced by Canadian winter conditions where potential exists for snowmelt during the winter, and of course for spring freshet to significantly impact on the surface water balance.

### *Humid Climate*

The climate conditions used in this exercise were adapted from a mine site in Alaska. The annual rainfall for the climate year was 900 mm while the annual potential evaporation was 604 mm. The mine site is subjected to moderate freezing conditions for half of the year. Rather than modelling the complex interaction of snowfall and freezing fronts on the performance of the cover system, the simulation period was reduced to only the 184 frost-free days at the mine site. The annual precipitation and potential evaporation values used in the modelling process are representative of this shortened modelling period.

The climate conditions at this site would be representative of conditions at numerous mine sites in Canada.

#### 4.3.2.2 Description of Simulated Cover System Designs

##### *Moisture Store-and-Release Cover*

The moisture store-and-release cover is designed to limit the infiltration of water to the underlying waste material. The cover utilizes a well-graded material to store moisture during wet periods for subsequent release to the atmosphere during dry periods. The cover system is simply a thick layer of cover material, usually ranging from 1.0 m to 4.0 m, overlying the waste material. The major advantage of the cover design is its low cost of construction since it only requires placement of the cover material and grading with suitable equipment such as a bulldozer.

The moisture store-and-release cover functions best in a climate with short periods of rainfall followed by prolonged dry periods. The moisture store-and-release cover acts like a sponge and absorbs water during precipitation events; the moisture is subsequently evaporated back to the atmosphere during the dry periods. The performance of the cover system is improved by the presence of vegetation that removes water at depth from within the profile. The moisture store-and-release cover does not create an adequate barrier to the ingress of oxygen. The saturation levels within the cover are generally low throughout the year, allowing oxygen to diffuse through the cover profile.

The moisture store-and-release covers modelled in this exercise ranged in thickness from 1.0 m to 4.0 m. The cover material is an inert relatively well-graded run-of-mine (ROM) waste rock with a saturated hydraulic conductivity of  $5 \times 10^{-2}$  cm/s. The model includes a 25 cm thick compacted waste rock layer at the base of the cover material, representative of a surface layer compacted by haul-truck traffic during placement of the cover material. The saturated hydraulic conductivity of the compacted waste rock layer is  $5 \times 10^{-5}$  cm/s.

### *Low Hydraulic Conductivity Compacted Cover*

The low hydraulic conductivity compacted barrier cover system is designed to limit the infiltration of both water and oxygen. The cover utilizes a soil layer with a low hydraulic conductivity, often created from the compaction of a clayey soil, to reduce the influx of water to the underlying waste. In addition, the compacted layer “holds” water maintaining a high degree of saturation and making it a good barrier against oxygen ingress. The low hydraulic conductivity compacted cover system usually consists of 30 to 50 cm of compacted clayey material overlying the waste material. A well-graded soil is placed on top of the compacted layer to act as protection against desiccation and frost action, and provide a suitable growth medium for vegetation.

The low hydraulic conductivity compacted barrier cover design is desirable when an adequate borrow source is available to produce a low hydraulic conductivity soil layer, although amelioration of coarser textured material with an off-site source of fine-textured material (e.g. bentonite) can also be implemented. The low hydraulic conductivity layer significantly reduces the downward percolation rate incurred during periods of high rainfall (and snowmelt if applicable). This allows the water to “build up” in the protection layer where it is available for evaporation and transpiration after the cessation of precipitation.

The compacted barrier design can be effective in limiting the ingress of both oxygen and water to the underlying waste material. Note that suitable materials to produce a low hydraulic conductivity layer are often unavailable on the mine site. Another disadvantage of this cover system design is the increased cost for placement and compacting of the material.

The low hydraulic conductivity cover design used in the modelling exercise incorporates an illitic or “non-active” clay material. The “poor” 50 cm compacted illitic clay layer at the base of the cover system has a saturated hydraulic conductivity of  $5 \times 10^{-6}$  cm/s. The saturated hydraulic conductivity of the layer was reduced to  $1 \times 10^{-7}$  cm/s to represent the “good” compacted barrier used in the simulations. The protection / growth medium layer placed on top of the compacted layer was the same illitic clay material, except it was non-compacted. The saturated hydraulic conductivity of this material was  $5 \times 10^{-4}$  cm/s.

### *Cover Incorporating a Capillary Barrier*

The capillary barrier concept is commonly used in the design of multi-layer cover systems. A capillary barrier results when a finer textured soil overlays a coarser textured soil, as illustrated in Figure 4.6. The design of a capillary barrier is dependent on the hydraulic properties of both the coarser and finer soils. Capillary barriers, unlike compacted barriers, do not rely solely on low hydraulic conductivity to restrict moisture movement into underlying material. Processes that increase hydraulic conductivity, such as desiccation and freeze-thaw, do not necessarily decrease the effectiveness of a capillary barrier.

The lower coarser textured soil may drain to a condition of residual moisture content if conditions allow. The residual suction for coarse-textured material is relatively low. The overlying finer textured soil will not drain at this low suction and as a result, it remains in a tension-saturated condition. This “capillary” break will occur during drainage whenever the residual suction of the lower coarser textured soil is less than the air entry value of the upper finer textured soil. A coarser textured cover overlying a finer textured soil layer may also be included in the design of a capillary barrier system to reduce evaporation from the finer textured layer. The upper coarser textured soil layer can reduce runoff, if the intensity is not too extreme, because it provides for storage of water following infiltration, thereby allowing some water to reach the underlying finer textured soil and satisfy any antecedent moisture losses.

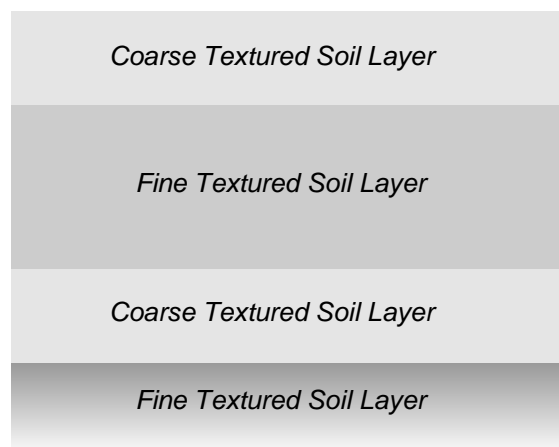

**Figure 4.6** A multi-layer cover system over waste material.

The capillary barrier concept is utilized in the design of cover systems to keep a central, fine-textured layer near saturation under all climatic conditions. This in turn limits the ingress of oxygen due to low oxygen diffusion conditions. In addition, the lower hydraulic conductivity of the finer textured soil layer (usually compacted), combined with the lower capillary barrier, reduces the net percolation to the underlying waste material.

The capillary break cover design can be effective in limiting the ingress of both oxygen and water to the underlying waste material. However, suitable materials to produce a capillary break are often unavailable on the mine site, or on-site materials must be processed (e.g. crushing, screening, etc.). Another disadvantage of the cover design is the increased cost of construction of a multi-layered soil cover system.

The multi-layered capillary break cover design used in the modelling exercise featured a growth medium, a fine-textured material layer, and two coarse capillary break layers. A 20 cm coarser textured layer ( $1 \times 10^{-3}$  cm/s) is placed on the waste material base, followed by a 60 cm finer textured

layer ( $1 \times 10^{-6}$  cm/s), another 20 cm thick coarser textured layer, and a 60 cm non-compacted growth medium layer on the top ( $2 \times 10^{-3}$  cm/s).

#### 4.3.2.3 SoilCover Modelling Program

The SoilCover analysis consisted of simulating each of the three climate types with each of the three cover systems to produce a matrix of results. Additional simulations were completed because the thickness of the well-graded material was varied from 1.0 to 4.0 m for the moisture store-and-release cover. The saturated hydraulic conductivity of the compacted barrier layer was altered from  $5 \times 10^{-6}$  cm/s for the “poor” barrier simulations to  $1 \times 10^{-7}$  cm/s for the “good” modelling simulations. The root depth of the vegetation was also varied for the low hydraulic conductivity barrier and capillary break simulations. Table 4.3 outlines the SoilCover simulations completed in the modelling programme. Table 4.4 shows the oxygen ingress and the net percolation for each SoilCover simulation. In addition, the net percolation is shown as a percentage of the annual precipitation.

##### *Semi-Arid Climate Simulations*

The moisture store-and-release cover performed well when subjected to the semi-arid climate conditions. Net percolation was greatest for the 1.0 m thick cover and decreased until no downward net percolation was simulated for the 4.0 m cover design. The annual oxygen mass flux values are greater than  $3500 \text{ g/m}^2$  for each of the model runs suggesting that the cover does not act as a suitable oxygen ingress barrier.

Negative or upward net percolation was predicted for the remaining “poor” and “good” low permeability barrier and capillary break simulations. This suggests that both cover systems would perform more than adequately in the semi-arid environment. The oxygen ingress is below  $1000 \text{ g/m}^2$  in all of compacted barrier simulations and approximately  $4200 \text{ g/m}^2$  for the capillary break simulations. This is likely a result of the growth medium and upper fine-textured layers becoming desiccated during the prolonged dry periods thus increasing diffusion of oxygen. The effect of increasing the root depth of the vegetation is not clear in the model simulations due to the upward percolation experienced within all the simulations. However, the oxygen flux does increase with the root depth suggesting that the moisture content in the compacted layers at the base of the cover designs is decreasing as a result of transpiration, leading to a lower degree of saturation and a higher oxygen diffusion rate.

*Seasonally Humid Climate Simulations*

The results show that the moisture store-and-release cover performed reasonably well in the seasonally humid climate conditions. Downward net percolation ranges from 50 mm for the 4.0 m cover to 80 mm for the 1.0 m cover. These percolation values are 3.5% to 5.5% of the annual precipitation, which suggests the cover can function adequately in these climate conditions. The oxygen ingress values are high, with the 4.0 m cover performing best at 1750 g/m<sup>2</sup>. The moisture store-and-release cover is suited to a seasonal climate provided that the storage capacity of the well-graded cover material is adequate to accommodate the high precipitation values of the wet season.

**Table 4.3**  
Summary of the SoilCover simulations.

Run #	Cover System	Leaf Area Index	Root Depth (cm)	Run #	Cover System	Leaf Area Index	Root Depth (cm)
Work1-1	Store and Release	None	N/A	Work3-10	"Good" Low Perm. Barrier	Excellent	50
Work1-2	Store and Release	None	N/A	Work3-11	"Good" Low Perm. Barrier	Excellent	75
Work1-3	Store and Release	None	N/A	Work3-12	"Good" Low Perm. Barrier	Excellent	100
Work1-4	Store and Release	None	N/A	Work3-13	"Good" Low Perm. Barrier	Excellent	150
Work1-5	"Poor" Low Perm. Barrier	Poor	50	Work3-14	"Good" Low Perm. Barrier	Excellent	200
Work1-6	"Poor" Low Perm. Barrier	Poor	50	Work3-15	Capillary Break	Excellent	30
Work1-7	"Poor" Low Perm. Barrier	Poor	50	Work3-16	Capillary Break	Excellent	45
Work1-8	"Poor" Low Perm. Barrier	Poor	50	Work3-17	Capillary Break	Excellent	60
Work1-9	"Poor" Low Perm. Barrier	Poor	50	Work4-1	Store and Release	Good	100
Work1-10	"Good" Low Perm. Barrier	Poor	50	Work4-2	Store and Release	Good	100
Work1-11	"Good" Low Perm. Barrier	Poor	50	Work4-3	Store and Release	Good	100
Work1-12	"Good" Low Perm. Barrier	Poor	50	Work4-4	Store and Release	Good	100
Work1-13	"Good" Low Perm. Barrier	Poor	50	Work4-5	"Poor" Low Perm. Barrier	Excellent	50
Work1-14	"Good" Low Perm. Barrier	Poor	50	Work4-6	"Poor" Low Perm. Barrier	Excellent	75
Work1-15	Capillary Break	Poor	45	Work4-7	"Poor" Low Perm. Barrier	Excellent	100
Work1-16	Capillary Break	Poor	45	Work4-8	"Poor" Low Perm. Barrier	Excellent	150
Work1-17	Capillary Break	Poor	45	Work4-9	"Poor" Low Perm. Barrier	Excellent	200
Work3-1	Store and Release	Good	100	Work4-10	"Good" Low Perm. Barrier	Excellent	50



**Table 4.3 (continued)**  
 Summary of the SoilCover simulations.

Run #	Cover System	Leaf Area Index	Root Depth (cm)	Run #	Cover System	Leaf Area Index	Root Depth (cm)
Work3-2	Store and Release	Good	100	Work4-11	“Good” Low Perm. Barrier	Excellent	75
Work3-3	Store and Release	Good	100	Work4-12	“Good” Low Perm. Barrier	Excellent	100
Work3-4	Store and Release	Good	100	Work4-13	“Good” Low Perm. Barrier	Excellent	150
Work3-5	“Poor” Low Perm. Barrier	Excellent	50	Work4-14	“Good” Low Perm. Barrier	Excellent	200
Work3-6	“Poor” Low Perm. Barrier	Excellent	75	Work4-15	Capillary Break	Excellent	30
Work3-7	“Poor” Low Perm. Barrier	Excellent	100	Work4-16	Capillary Break	Excellent	45
Work3-8	“Poor” Low Perm. Barrier	Excellent	150	Work4-17	Capillary Break	Excellent	60
Work3-9	“Poor” Low Perm. Barrier	Excellent	200				

The performance of the “poor” low hydraulic conductivity compacted barrier system is not quite as good. Percolation values range from a high of 16% of the annual precipitation down to 5%. The positive effect of vegetation on net percolation is evident in these simulations. The improvement in performance is a result of the root depth being increased from 50 cm (16% of annual precipitation) to 200 cm (5% of annual precipitation). The increased root depth “pulls” the infiltrated water back out of the protection / growth medium layer and the compacted layer. When the vegetation root depth is only 50 cm infiltrated water deep in the protection / growth medium layer cannot be reached to be “pulled” back out of the cover before it percolates through the compacted barrier layer. The oxygen ingress values for each of the simulations is below 400 g/m<sup>2</sup>, implying that the compacted layer is maintaining its tension-saturation level reasonably well and functioning as a reasonable barrier to oxygen ingress.

Decreasing the saturated hydraulic conductivity of the compacted barrier layer improves the performance of the cover design. The net percolation for these simulations was below 5.0% of the annual precipitation. The improvement in performance is likely due to reduced rate at which infiltration water can percolate through the compacted layer. Water pools at the base of the growth medium layer during the high precipitation periods, but then it is pulled back out of the cover through evapotranspiration during the subsequent dry periods before it can percolate through the compacted layer.

The capillary break cover design performed well in the seasonally humid climate. The net percolation percentage is slightly higher than the “good” compacted barrier simulations but the oxygen ingress fluxes are lower. The low oxygen ingress values suggest that the fine-textured layer within the cover design is staying close to saturation reducing the diffusion rate through the cover. Variation of the

root depth of the vegetation from 30 cm to 60 cm seemed to have little effect on the simulation. The prolonged dry periods quickly bring the suction to the wilting point effectively stopping any vegetation transpiration.

**Table 4.4**  
Summary of the results of the SoilCover simulations.

Semi Arid Climate				Seasonally Humid Climate			
Run #	Net Perc. (mm)	Net Perc. (% of precip.)	Oxygen Flux (g/m <sup>2</sup> )	Run #	Net Perc. (mm)	Net Perc. (% of precip.)	Oxygen Flux (g/m <sup>2</sup> )
Work1-1	13.4	2.9%	9,540	Work3-1	80.1	5.5%	8,140
Work1-2	12.5	2.7%	5,190	Work3-2	61.8	4.2%	2,990
Work1-3	2.9	0.6%	4,180	Work3-3	59.2	4.1%	2,140
Work1-4	-2.4	upward	3,720	Work3-4	49.5	3.4%	1,750
Work1-5	-21.8	upward	554	Work3-5	233	16.0%	174
Work1-6	-24.4	upward	641	Work3-6	197	13.5%	193
Work1-7	-26.6	upward	749	Work3-7	154	10.5%	227
Work1-8	-28.6	upward	893	Work3-8	116	7.9%	278
Work1-9	-30.1	upward	1,110	Work3-9	76.5	5.2%	380
Work1-10	-2.1	upward	560	Work3-10	72.6	5.0%	162
Work1-11	-2.2	upward	599	Work3-11	67.5	4.6%	178
Work1-12	-2.3	upward	649	Work3-12	58.7	4.0%	204
Work1-13	-2.4	upward	693	Work3-13	48.5	3.3%	236
Work1-14	-2.4	upward	725	Work3-14	41.4	2.8%	272
Work1-15	-1.9	upward	4,250	Work3-15	112	7.7%	28.3
Work1-16	-1.9	upward	4,250	Work3-16	112	7.7%	29.0
Work1-17	-1.9	upward	4,250	Work3-17	112	7.7%	29.0

**Table 4.4 (cont'd)**  
Summary of the results of the SoilCover simulations.

<b>Humid Climate</b>			
<b>Run #</b>	<b>Net Perc. (mm)</b>	<b>Net Perc. (% of precip.)</b>	<b>Oxygen Flux (g/m<sup>2</sup>)</b>
Work4-1	271	30.1%	1,900
Work4-2	255	28.3%	710
Work4-3	265	29.5%	417
Work4-4	238	26.5%	319
Work4-5	368	40.8%	31.2
Work4-6	355	39.4%	33.6
Work4-7	340	37.7%	36.8
Work4-8	326	36.2%	40.1
Work4-9	312	34.6%	44.2
Work4-10	75.6	8.4%	17.6
Work4-11	72.9	8.1%	19.3
Work4-12	70.2	7.8%	21.3
Work4-13	68.1	7.6%	23.0
Work4-14	66.2	7.3%	24.4
Work4-15	110.2	12.2%	3.35
Work4-16	110.1	12.2%	3.35
Work4-17	110.0	12.2%	3.35

#### *Humid Climate Simulations*

The application of the humid climate to the moisture store-and-release cover resulted in high percolation values (26 to 30% of annual precipitation). The moisture store-and-release cover is not adequate to cover mine waste in this type of environment. The moisture store-and-release cover relies on prolonged dry periods to promote evapotranspiration that are not present in this type of humid climate.

The performance of the “poor” compacted barrier system was also undesirable since more than one-third of the annual precipitation percolated through the cover. The low oxygen ingress values show that the compacted layer was likely close to saturation for most of the simulation period allowing water to percolate into the waste material at a rate of  $5 \times 10^{-6}$  cm/s (4.3 mm/day).

The advantage of having a “good” compacted barrier is evident in the Work4-10 to Work4-14 simulations. The performance of the “good” compacted barrier cover was almost five times better than the “poor” barrier with net percolation approximately 8% of the annual precipitation. The oxygen ingress values are also low showing that the low hydraulic conductivity compacted barrier cover system can adequately limit both oxygen and water from reaching the underlying waste material.

Similar to the seasonally humid case, the capillary break did not perform as well as the compacted barrier in limit water percolation but was better in reducing oxygen ingress. The net percolation values are greater than 12% of the annual precipitation. This value is fairly high for a capillary break system. The large amount of precipitation in the short summer season results in an increased water content within the coarse and fine-textured layers. At levels close to saturation, as experienced from this humid climate, the capillary break does not function as well because the coarse layer is not drained, resulting in a higher hydraulic conductivity. Percolation through the cover system generally becomes dependent on the saturated hydraulic conductivity of the fine-textured layer, which in these simulations is  $1 \times 10^{-6}$  cm/s. This value of hydraulic conductivity is not adequate to keep the infiltrated water close enough to the surface where evapotranspiration can remove it from the profile.

#### 4.3.2.4 Summary and Conclusions from SoilCover Modelling Example 2

The SoilCover modelling exercise showed that appropriate cover design is heavily dependent on the climate conditions and available materials on the mine site. For example, the moisture store-and-release cover that functioned well in the semi-arid climate was less effective in the seasonally humid climate and performed poorly in the humid climate. The value of a low hydraulic conductivity material layer was also demonstrated, the “poor” compacted barrier performed well in semi-arid climate, adequately in the seasonally humid climate, and very poorly in the humid climate. The “good” compacted barrier system, in comparison, performed well in all three climate conditions. However, the practicality of utilizing this cover system for sites located arid to semi-arid climate conditions must be questioned because the simpler moisture store-and-release cover system design could be utilized for significantly lower cost.

## 4.4 Two-Dimensional Modelling

The site described in Section 4.3.1 (SoilCover Modelling Example 1) is used to provide examples of two-dimensional (2-D) cover system performance. The design of a soil cover on the side-slopes of a waste rock pile requires that the two-dimensional nature of the flow regime within the cover be characterized. Water movement can be assumed to be one-dimensional for horizontal soil layers; however, the inclusion of a sloped surface on the waste rock side-slope creates a two-dimensional flow regime. The purpose of this section is to demonstrate a methodology for the numerical analysis of water movement along a sloping waste rock cover system. The example is not intended to be a rigorous examination of the cover alternatives; rather it is meant to examine how the flow patterns within the cover materials vary as the texture and the thickness of these layers are altered.

SEEP/W is a two-dimensional finite element software product that can be used to simulate the isothermal flow of water within saturated or unsaturated porous materials (Geo-Slope International Ltd., 1999).

SEEP/W was used to model the flow of infiltration water through a sloping waste rock cover system. The cover slope was assumed to span a vertical distance of 10 m with the upper part of the slope possessing a 20% slope and the lower part a 14% slope. Two cover systems were examined in the modelling process, a “barrier” cover system involving two soil types and a “transmission” cover system comprised of three soil types. The thickness of the cover materials was varied to evaluate the effect this has on the flow system. Steady-state and transient model runs were completed. Table 4.5 lists the components of each model simulation.

**Table 4.5**  
Summary of the SEEP/W models.

Model Name	Growth Medium Thickness (m)	Compacted Layer Thickness (m)	CB Layer Thickness (m)	Infiltration Rate (mm/yr)	Model Type
Basic	1.00	0.50	-	10	Barrier
<i>Basic2</i>	<i>2.00</i>	<i>0.50</i>	-	<i>10</i>	<i>Barrier</i>
<i>Basic2b</i>	<i>2.00</i>	<i>0.50</i>	-	<i>100</i>	<i>Barrier</i>
<i>Basic2c</i>	<i>2.00</i>	<i>0.50</i>	-	<i>500</i>	<i>Barrier</i>
Basic3	2.25	0.25	-	10	Barrier
Basic3b	2.25	0.25	-	100	Barrier
Basic3c	2.25	0.25	-	500	Barrier
Basic4	1.25	0.50	-	10	Barrier
Basic5	1.50	0.50	-	10	Barrier
Basic5b	1.50	0.50	-	100	Barrier
Basic5c	1.50	0.50	-	500	Barrier
Basic6	1.25	0.25	-	10	Barrier
Basic7	1.50	0.25	-	10	Barrier
Basic8	2.00	0.25	-	10	Barrier
<i>Capillary</i>	<i>1.75</i>	<i>0.50</i>	<i>0.25</i>	<i>10</i>	<i>Transmission</i>
<i>Capillaryb</i>	<i>1.75</i>	<i>0.50</i>	<i>0.25</i>	<i>100</i>	<i>Transmission</i>
<i>Capillaryc</i>	<i>1.75</i>	<i>0.50</i>	<i>0.25</i>	<i>500</i>	<i>Transmission</i>
Capillary2	1.00	0.50	0.25	10	Transmission
Capillary2b	1.00	0.50	0.25	100	Transmission

**Table 4.5 (continued)**  
Summary of the SEEP/W models.

Model Name	Growth Medium Thickness (m)	Compacted Layer Thickness (m)	CB Layer Thickness (m)	Infiltration Rate (mm/yr)	Model Type
Capillary2c	1.00	0.50	0.25	500	Transmission
Capillary3	1.00	0.25	0.25	10	Transmission
Capillary3b	1.00	0.25	0.25	100	Transmission
Capillary3c	1.00	0.25	0.25	500	Transmission
Capillary4	0.50	0.50	0.25	10	Transmission
Capillary4b	0.50	0.50	0.25	100	Transmission
Capillary4c	0.50	0.50	0.25	500	Transmission

The barrier cover utilizes a layer of low hydraulic conductivity compacted soil overlain by a thicker, non-compacted, higher hydraulic conductivity layer. As the infiltrating water overcomes the storage capabilities of the non-compacted surface material, it will migrate to the non-compacted / compacted soil contact. The majority of the water will not enter the lower hydraulic conductivity compacted layer. It will flow down the slope within the non-compacted surface layer where the water can be collected and channelled away. This prevents the infiltrating water from entering the waste rock material. Figure 4.7 shows an example of the simulated “barrier” cover system.

The transmission cover is constructed in a similar manner to the barrier cover. However, this system incorporates a thin, high hydraulic conductivity coarse rock layer between the non-compacted and compacted layers. This coarse layer represents a preferential flow path that effectively transmits water to the base of the waste rock pile. A typical “transmission” cover system configuration is shown in Figure 4.8.

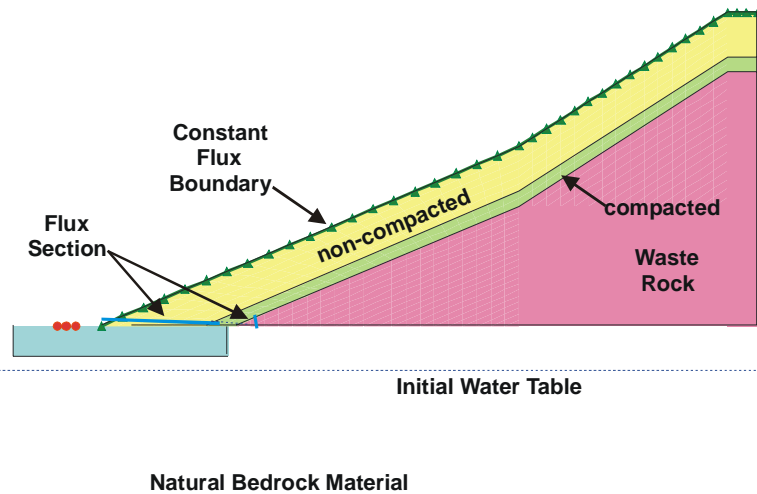

**Figure 4.7** Example of a “barrier” layer cover system on a sloping waste rock surface.

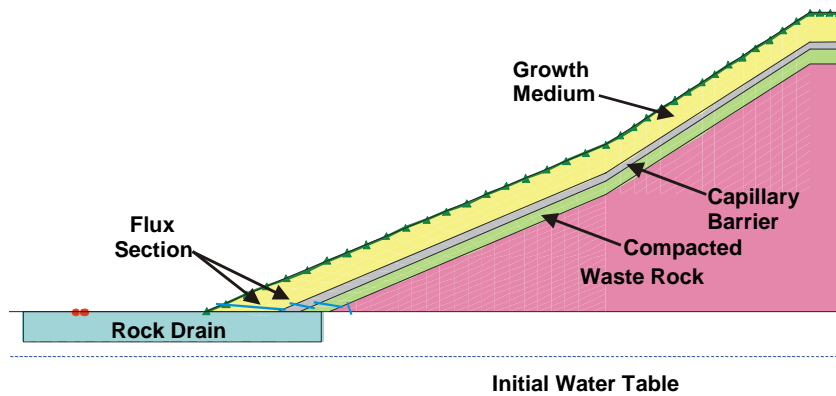

**Figure 4.8** Example of a “transmission” cover system on a sloping waste rock surface.

The surface flux boundary conditions for the model were based on the values predicted in the one-dimensional soil-atmosphere flux simulations.

SEEP/W contains numerous options to view the graphical results from each model run. In this example, flux sections were input to monitor the steady-state seepage rate from each cover layer. These seepage rates were compared to the total boundary flux (i.e. the moisture added to the model across the surface of the cover) to establish the total percentage of infiltration diverted from entering the underlying waste rock material. Additionally, the pressure head profiles and flow vectors were monitored for each model simulation.

#### 4.4.1 Steady-State Analysis

The steady-state simulations were undertaken at three intensities of infiltration: 10 mm/yr, 100 mm/yr, and 500 mm/yr. A total of eight “barrier” models and four “transmission” models were examined. Each infiltration case was investigated for each model; and soil layer thickness was varied in each model. Flux sections were established in each of the material layers to monitor the magnitude of the steady-state seepage. These flux values were compared to the total flux applied to the sloping cover system surface to calculate the percentage of infiltration diverted from entering the waste rock material. Table 4.6 summarizes the efficiency of each simulation case in eliminating infiltration into the waste rock.

Figure 4.9 shows the graphical output for steady-state model Capillary2b. The flow vectors are concentrated within the thin CB layer, demonstrating that 88% of the flow is being transmitted within this layer. The pressure head contours within the growth medium, capillary barrier layer, and compacted layers are also shown in Figure 4.9, and the results show that the lower portion of the slope is in a saturated condition.

**Table 4.6**

Summary of total flow diverted from the underlying waste rock with high quality cover system.

Name	Boundary Flow (m <sup>2</sup> /s)	Percentage of Boundary Flow			Total % Flow Diverted from Waste Rock
		Growth	Compacted	CB Layer	
Basic	1.37E-08	3.79%	5.52%	-	9.32%
Basic2	1.53E-08	97.8%	0.37%	-	98.2%
Basic2b	1.53E-07	97.8%	0.25%	-	98.1%
Basic2c	7.64E-07	98.1%	0.32%	-	98.4%
Basic3	1.53E-08	97.8%	0.82%	-	98.6%
Basic3b	1.53E-07	97.8%	0.62%	-	98.4%
Basic3c	7.64E-07	98.1%	0.53%	-	98.6%
Basic4	1.40E-08	1.78%	4.11%	-	5.89%
Basic5	1.44E-08	97.4%	0.78%	-	98.2%
Basic5b	1.44E-07	97.4%	0.55%	-	98.0%
Basic5c	7.16E-07	97.7%	0.70%	-	98.4%
Basic6	1.37E-08	1.33%	3.13%	-	4.45%
Basic7	1.40E-08	1.40%	3.12%	-	4.51%
Basic8	1.49E-08	1.41%	3.09%	-	4.50%
Capillary	1.53E-08	16.8%	0.00%	81.5%	98.3%
Capillaryb	1.53E-07	16.8%	0.00%	81.5%	98.3%
Capillaryc	7.64E-07	16.7%	0.00%	81.6%	98.4%
Capillary2	1.42E-08	10.2%	0.00%	88.0%	98.2%
Capillary2b	1.42E-07	10.2%	0.00%	88.0%	98.2%
Capillary2c	7.08E-07	10.2%	0.00%	88.0%	98.2%
Capillary3	1.37E-08	64.4%	0.02%	152%	216%
Capillary3b	1.37E-07	60.1%	0.01%	158%	218%
Capillary3c	6.84E-07	60.1%	0.01%	156%	216%
Capillary4	1.34E-08	5.27%	0.00%	93.3%	98.6%
Capillary4b	1.34E-07	5.27%	0.00%	93.3%	98.6%
Capillary4c	6.68E-07	5.27%	0.00%	93.2%	98.5%

The SEEP/W models of the cover system were revisited to explore the use of a moderate quality cover system along with a sloping geometry to enhance the diversion of surface infiltration. The same modelling process as described above was completed to evaluate the performance of this cover. The results of the additional programme are summarized in Table 4.7.



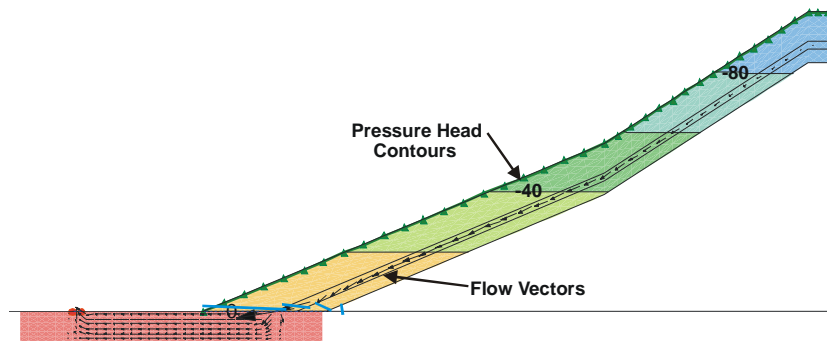

**Figure 4.9** Graphical output for steady-state model Capillary2b.

**Table 4.7**

Summary of the total flow diverted from the waste rock with compacted material.

Model Name	Boundary Flow (m <sup>2</sup> /s)	Percentage of Boundary Flow			Total % Flow Diverted from Waste Rock
		Growth	Compacted (moderate)	CB Layer	
Basic.sep	1.37E-08	1.23%	12.6%	-	13.8%
<i>Basic2.sep</i>	<i>1.53E-08</i>	<i>78.7%</i>	<i>35.4%</i>	-	<i>114%</i>
<i>Basic2b.sep</i>	<i>1.53E-07</i>	<i>85.0%</i>	<i>23.0%</i>	-	<i>108%</i>
<i>Basic2c.sep</i>	<i>7.64E-07</i>	<i>85.0%</i>	<i>23.0%</i>	-	<i>108%</i>
Basic3.sep	1.53E-08	56.9%	17.5%	-	74.4%
Basic3b.sep	1.53E-07	70.3%	12.7%	-	83.0%
Basic3c.sep	7.64E-07	70.3%	12.7%	-	83.0%
Basic4.sep	1.40E-08	5.21%	6.98%	-	12.2%
Basic5.sep	1.44E-08	1.31%	13.7%	-	15.1%
Basic5b.sep	1.44E-07	1.26%	13.8%	-	15.0%
Basic5c.sep	7.16E-07	1.33%	13.7%	-	15.1%
Basic6.sep	1.37E-08	5.33%	7.27%	-	12.6%
Basic7.sep	1.40E-08	48.2%	20.2%	-	68.4%
Basic7b.sep	1.40E-07	61.9%	16.2%	-	78.1%
Basic7c.sep	7.00E-07	61.9%	16.2%	-	78.1%
Basic8.sep	1.49E-08	6.31%	8.27%	-	14.6%
<i>Capillary.sep</i>	<i>1.53E-08</i>	<i>12.2%</i>	<i>0.09%</i>	<i>135%</i>	<i>147%</i>
<i>Capillaryb.sep</i>	<i>1.53E-07</i>	<i>1.29%</i>	<i>0.14%</i>	<i>79.2%</i>	<i>80.6%</i>
<i>Capillaryc.sep</i>	<i>7.64E-07</i>	<i>5.65%</i>	<i>0.09%</i>	<i>44.6%</i>	<i>50.3%</i>
Capillary2.sep	1.42E-08	25.4%	0.23%	134%	160%
Capillary2b.sep	1.42E-07	15.1%	0.42%	75.3%	90.8%
Capillary2c.sep	7.08E-07	14.2%	0.07%	76.2%	90.4%
Capillary3.sep	1.37E-08	67.2%	0.16%	162%	229%
Capillary3b.sep	1.37E-07	49.9%	0.39%	132%	182%

**Table 4.7 (continued)**

Summary of the total flow diverted from the waste rock with compacted material.

Model Name	Boundary Flow (m <sup>2</sup> /s)	Percentage of Boundary Flow			Total % Flow Diverted from Waste Rock
		Growth	Compacted (moderate)	CB Layer	
Capillary3c.sep	6.84E-07	73.4%	0.01%	186%	260%
Capillary4.sep	1.34E-08	12.5%	0.01%	111%	123%
Capillary4b.sep	1.34E-07	24.6%	0.02%	108%	133%
Capillary4c.sep	6.68E-07	23.3%	0.03%	103%	126%

Table 4.7 summarizes the performance of a moderate quality cover system compared to that of a high quality cover system when constructed along a side slope. The “basic” model and the “barrier” model simulations illustrate the difference in performance. Note that the model runs “Basic2”, “Basic2b”, and “Basic2c”, represent a 0.5 m thick compacted layer overlain by a 2.0 m non-compacted layer. The saturated hydraulic conductivity of the compacted layer in the moderate quality cover system is  $5.0 \times 10^{-6}$  cm/s, compared to a saturated conductivity of  $5.0 \times 10^{-8}$  cm/s for the high quality cover system. Three of the “basic” models utilizing the latter system diverted over 98% of the total flow from the waste rock, as shown in Table 4.6. Only model run Basic2 showed similar results when the compacted moderate quality cover material was implemented, as shown in Table 4.7. However, it should be noted that under the conditions of this simulation the moderate quality cover system does perform with the same high level of reduction in net percolation. This demonstrates the difference in performance for the same cover system modelled as a 1-D or a 2-D system.

#### 4.4.1.1 Discussion of Simulated 2-D Performance

The “barrier” and “transmission” cover systems constructed over sloping waste rock performed well in the steady-state and transient (not shown) models. The barrier cover systems require an adequately thick, non-compacted layer to properly store and divert water down the slope. The thin coarse rock layer within the transmission design provides a preferential pathway for the flow of infiltration to the toe of the slope. Both the “barrier” and “transmission” cover systems appear to be technically feasible in preventing infiltration. The design of the final cover system should incorporate other factors such economic and construction feasibility to determine which cover system design is most suitable.

## REFERENCES

- American Society for Testing and Materials (ASTM). 1990. Standard test method for particle size analysis of soils (D422-63; Reapproved 1990). *In* 1998 Annual Book of ASTM Standards, Vol. 4.08. ASTM, Philadelphia, Pa.
- American Society for Testing and Materials (ASTM). 1991. Test method for laboratory compaction characteristics of soil using standard effort (D698-91). *In* 1998 Annual Book of ASTM Standards, Vol 4.08. ASTM, Philadelphia, Pa.
- American Society for Testing and Materials (ASTM). 1992a. Standard test method for laboratory determination of water (moisture) content of soil and rock (D2216-92). *In* 1998 Annual Book of ASTM Standards, Vol. 4.08. ASTM, Philadelphia, Pa.
- American Society for Testing and Materials (ASTM). 1992b. Standard test method for specific gravity of soils (D854-92). *In* 1998 Annual Book of ASTM Standards, Vol. 4.08. ASTM, Philadelphia, Pa.
- American Society for Testing and Materials (ASTM). 1995. Test method for liquid limit, plastic limit, and plasticity index of soils (D4318-95a). *In* 1998 Annual Book of ASTM Standards. Vol. 4.08. ASTM, Philadelphia, Pa.
- American Society for Testing and Materials (ASTM). 1996. Standard test method for one-dimensional consolidation properties of soils (D2435-96). *In* 1998 Annual Book of ASTM Standards, Vol. 4.08. ASTM, Philadelphia, Pa.
- American Society for Testing and Materials (ASTM). 2003. Standard test methods for laboratory compaction characteristics of soil using modified effort. (D1557-02e1). *In* 2003 Annual Book of ASTM Standards, Vol 4.08. ASTM, Philadelphia, Pa.
- American Society for Testing and Materials (ASTM). 2003. Standard Test Methods for Determination of the Soil Water Characteristic Curve for Desorption Using a Hanging Column, Pressure Extractor, Chilled Mirror Hygrometer, and/or Centrifuge. (D6836-02). *In* 2003 Annual Book of ASTM Standards, Vol 4.09. ASTM, Philadelphia, Pa.
- Aubertin, M., Achib, M., and Authier, K. 2000. Evaluation of diffusive flux through covers with a GCL. *Geotextiles and Geomembranes*. 18: 215-233.
- Bowles, J.E. 1992. *Engineering Properties of Soils and their Measurement*, 4th Edition. McGraw-Hill Inc. Boston, MA.
- British Columbia AMD Task Force. 1989. *Draft Acid Rock Drainage Technical Guide*, Vol. I, Crown Publications, Victoria, B.C.
- Chapuis, R.P., Chenaf, D., Bussi re, B., Aubertin, M., and Crespo, R. 2001. A user's approach to assess numerical codes for saturated and unsaturated seepage conditions. *Canadian Geotechnical Journal*. 38(5): 1113-1126.
- Edlefsen, N.E. and Anderson, A.B.C. 1943. *Thermodynamics of Soil Moisture*. Hilgardia, Vol. 15, pp. 31-298.
- Elberling, B., and Nicholson, R.V. 1996. Field determination of sulphide oxidation rates in mine tailings. *Water Resources Research*. 32(6) 1773-1784.
- Freeze, R.A. and Cherry, J.A. 1979. *Groundwater*. Prentice-Hall, Inc., Englewood Cliffs, NJ.

- GeoAnalysis 2000 Ltd., 2001. SoilCover Version 5.2 User's Manual.
- Geo-Slope International Ltd., 1999. SEEP/W Version 4.22 User's Manual. Geo-Slope International Ltd., Calgary, AB.
- Geo-Slope International Ltd., 2002. VADOSE/W Version 1 User's Manual. Geo-Slope International Ltd., Calgary, AB.
- Lawrence, R.W. and Wang, Y. 1997. Determination of Neutralization Potential in the Prediction of Acid Rock Drainage, In Proceedings of the 4th International Conference on Acid Rock Drainage, Vancouver, BC, pp. 449-464.
- Lewis, H.S., Susteyo, W., Miller, S.D., and Jeffery, J.J. 1997. Waste Rock Management Planning and Implementation at P.T. Freeport Indonesia Company's Mining Operations in Irian Jaya. In Proceedings of the Fourth International Conference on Acid Rock Drainage, Vancouver, B.C., Canada, 1997, Vol III, pp. 1361-1376.
- Meiers, G.M., Barbour, S.L. and Meiers, M.K. 2003. The use of field measurements of hydraulic conductivity to characterise the performance of reclamation soil covers with time. In Proceedings of the Sixth International Conference on Acid Rock Drainage, July 14-17, Cairns, Queensland, Australia, pp. 1085-1090.
- MEND 1.16.1a. 1989. Investigation of Prediction Techniques for Acid Mine Drainage, November.
- MEND 1.16.1b. 1991. Acid Rock Drainage Prediction Manual, March.
- MEND 1.25.1. 1996. SoilCover Users Manual Version 2.0 (includes diskettes), December.
- MEND 5.4.2c. 2000. MEND Manual: Volume 3 – Prediction, December.
- MEND 5.4.2-D. 2001. MEND Manual: Volume 4 – Prevention and Control. February.
- Miller, S., Robertson, A., and Donohue, T. 1997. Advances in Acid Drainage Prediction Using The Net Acid Generation (NAG) Test. In: Proceedings of the Fourth International Conference on Acid Rock Drainage, Vancouver, B.C., Canada, 1997, vol II, pp. 535-547.
- O'Kane, M. 1996. Instrumentation and Monitoring of an Engineered Soil Cover System for Acid Generating Mine Waste. M.Sc. Thesis, Department of Civil Engineering, University of Saskatchewan, Saskatoon, Saskatchewan, Canada.
- Sobek, A.A., Schuller, W.A. Freeman, J.R. and Smith, R.M. (1978), Field and Laboratory Methods Applicable to Overburden and Minesoils, EPA 600/2-78-054, 203 pp.
- Wilson, G.W. 1990. Soil evaporative fluxes for geotechnical engineering problems. Ph.D. Thesis, Department of Civil Engineering, University of Saskatoon, Saskatchewan, Canada.
- Wilson, G.W., Fredlund, D.G. and Barbour, S.L. 1994. Coupled soil-atmosphere modelling for soil evaporation. Canadian Geotechnical Journal. Vol. 31, pp. 151-161.
- Wong, L.C. and Haug, M.D., 1991. Cyclical closed system freeze-thaw permeability testing of soil liner and cover materials. Canadian Geotechnical Journal, Vol. 28, pp. 784-793.
- Yanful, E., Haug, M.D. and Wong, L.C., 1990. The impact of synthetic leachate on the hydraulic conductivity of a smectitic till underlying a landfill near Saskatoon, Saskatchewan. Canadian Geotechnical Journal, Vol. 27, pp. 507-519.

Young, J.F. 1967. Humidity control in the laboratory using salt solutions – a review. *Journal of Applied Chemistry*. 17: 241-245.